



High Performance from Rexnord

**RexPro Roller chains | European type**

**REXNORD**

**RexPro**  
RexPro lubrication  
improved wear resistance  
high fatigue resistance

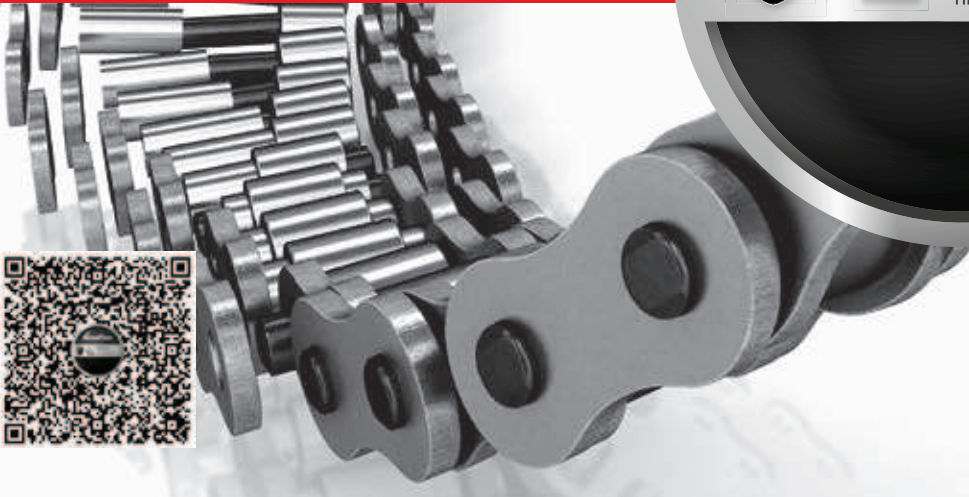

## Roller chains - European type

High Performance from Rexnord.

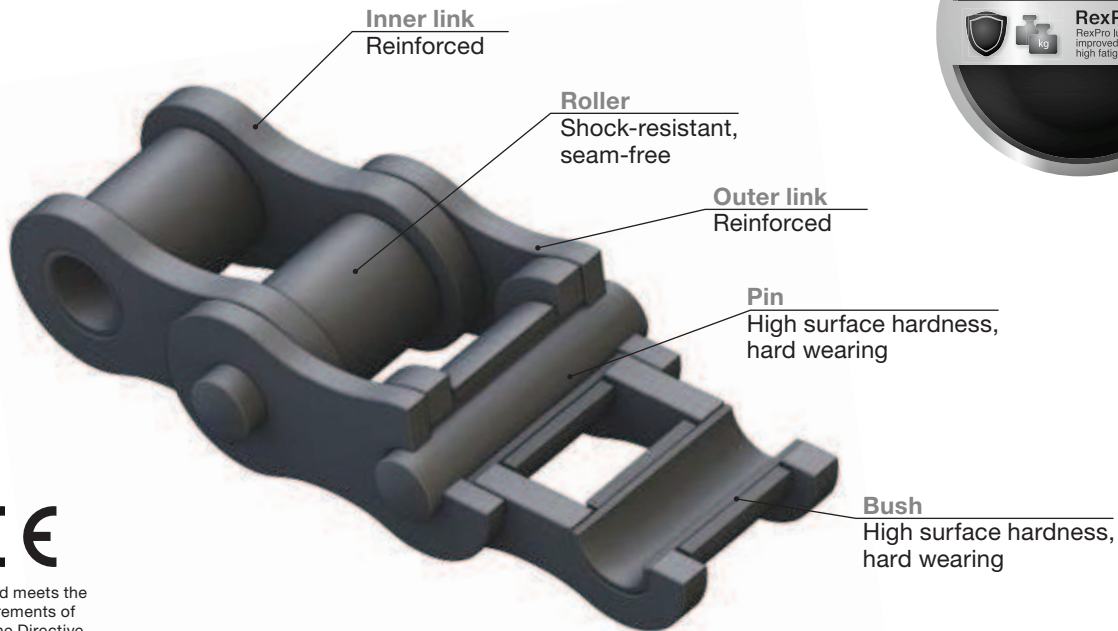

Rexnord meets the requirements of Machine Directive 2006/42/EC

### APPLICATIONS

- Automotive, textile and steel industry, bottling and beverage plants, agricultural machinery, construction machinery
- Food and confectionery industry, packing industry, conveyor engineering
- Pharmaceutical industry, paper and wood processing, machine and plant manufacturers

### CHARACTERISTICS

- High fatigue resistance
- Improved wear resistance
- Outstanding corrosion protection
- Very environmentally friendly
- Manufactured from high-performance materials
- Ball-drifted plate holes
- Seam-free rollers
- Shot-peened pins, plates, bushes and rollers
- Delivered adjusted and torsion-free on request
- NSF H2 certification, RoHS:2005 compliant

### ADVANTAGES

- Minimal bedding-in elongation
- Longer working life
- Very high impact strength
- Very robust under the toughest conditions
- Maximum operating reliability
- Improved cost-effectiveness

### LUBRICATION

- RexPro lubrication without heavy metals for improved protection
- Operating temperature: -30° C to +130° C (can be extended from -40° C to +250° C)
- Very good surface adhesion; remains drip resistant even at high temperatures
- No heavy metals, Teflon- and silicone-free

RexPro - High performance from Rexnord



**Excellent Corrosion Protection**

- 8 - 10 times better than the best competitors
- More than 100 % better in the buckling test
- Highly versatile, also suitable for aggressive environments



**Improved Wear Resistance**

- 8 - 12 % improvement in comparison to predecessor
- Great protection through RexPro lubrication
- Long working life
- High operating reliability



**High Fatigue Resistance**

- Ball-drifted plate holes
- Shot-peened chain links, seam-free rollers
- High pre-loading



**Eco friendly**

- Through RexPro lubrication
- No heavy metals; Teflon- and silicone-free
- Environmental management system conforms to DIN EN ISO 14001

Salt spray test in accordance with DIN EN ISO 9227

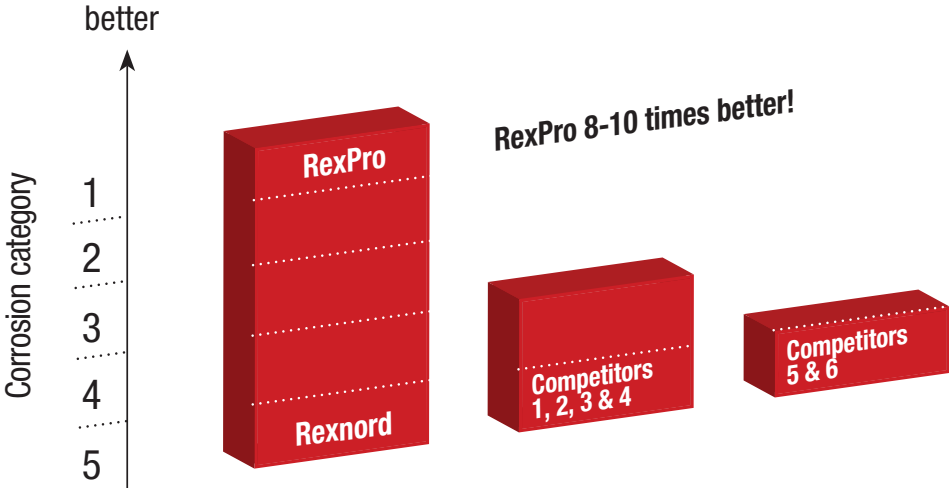

Rexnord meets the requirements of Machine Directive 2006/42/EC

## Roller chains - European type

High Performance from Rexnord.

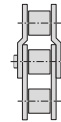

### Simplex roller chains



**CE**  
Rexnord meets the requirements of Machine Directive 2006/42/EC



#### Excellent Corrosion Protection

- 8 - 10 times better than the best competitors
- More than 100 % better in the buckling test
- Highly versatile, also suitable for aggressive environments



#### Improved Wear Resistance

- 8 - 12 % improvement in comparison to predecessor
- Great protection through RexPro lubrication
- Long working life
- High operating reliability



#### High Fatigue Resistance

- Ball-drifted plate holes
- Shot-peened chain links, seam-free rollers
- High pre-loading



#### Eco friendly

- Through RexPro lubrication
- No heavy metals; Teflon- and silicone-free
- Environmental management system conforms to DIN EN ISO 14001

## Simplex roller chains, ISO 606 / DIN 8187

Chain No.	Pitch		Width between inner plates		Roller diameter	Pin diameter	Width over inner link	Plate depth	Pin length	Connecting pin length	Bearing area	Required minimum tensile strength DIN/ISO	Average tensile strength	Weight	Loose parts					
	Inch	mm	b <sub>1</sub> min	d <sub>1</sub> max	d <sub>2</sub> max	b <sub>2</sub> max	g	a <sub>1</sub> max	a <sub>3</sub> max	A	F <sub>u</sub>	F <sub>b</sub>	q	A	B	C	E	L	S	
			mm	mm	mm	mm	mm	mm	mm	mm	mm	cm <sup>2</sup>	N	N	kg/m					
04		6	2.80	4.00	1.85	4.10	5.0	7.4	10.3	0.08	3 000	3 000	0.2			x	x			
05 B - 1		8	3.00	5.00	2.31	4.77	7.1	8.6	11.7	0.11	4 400	4 400	0.2			x	x			
06 B - 1	0.375	9.52	5.72	6.35	3.28	8.53	8.2	13.5	16.8	0.28	8 900	9 000	0.5			x	x			
083	0.50	12.7	4.88	7.75	4.09	7.90	10.3	12.9	14.4	0.32	12 000	12 000	0.5			x	x	x		
084	0.50	12.7	4.88	7.75	4.09	8.80	11.1	14.8	16.3	0.326	16 000	16 000	0.6			x	x	x		
08 B - 1	0.50	12.7	7.75	8.51	4.45	11.30	11.6	17.0	20.9	0.50	17 800	21 000	0.7	x	x	x	x	x		
10 B - 1	0.625	15.87	9.65	10.16	5.08	13.28	14.6	19.6	23.7	0.67	22 200	25 000	0.9	x	x	x	x	x		
12 B - 1	0.75	19.05	11.68	12.07	5.72	15.62	15.9	22.7	27.3	0.89	28 900	32 000	1.2	x	x	x	x	x		
16 B - 1	1.00	25.4	17.02	15.88	8.28	25.40	20.5	36.1	42.4	2.10	60 000	80 000	2.6	x	x	x	x	x	x	
20 B - 1	1.25	31.75	19.56	19.05	10.19	29.00	25.7	40.4	47.6	2.96	95 000	120 000	3.7	x	x				x	
24 B - 1	1.50	38.1	25.40	25.40	14.63	37.90	33.0	53.8	60.6	5.54	160 000	211 000	6.9	x	x				x	
28 B - 1	1.75	44.45	30.99	27.94	15.90	46.50	37.0	63.3	72.8	7.39	200 000	256 000	8.6	x	x				x	
32 B - 1	2.00	50.8	30.99	29.21	17.81	45.50	41.2	65.1	73.6	8.10	250 000	315 000	9.5	x	x				x	
40 B - 1	2.50	63.5	38.10	39.37	22.89	55.70	51.5	78.9	91.3	12.7	355 000	380 000	15.1	x	x				x	
48 B - 1	3.00	76.2	45.72	48.26	29.24	70.50	63.5	98.5	124.0	20.6	560 000	600 000	24.5	x	x				x	
56 B - 1	3.50	88.9	53.34	53.98	34.32	81.30	77.0	114.7	140.0	27.9	850 000	950 000	36.5	x	x				x	
64 B - 1	4.00	101.6	60.96	63.50	39.40	92.00	93.3	130.0	143.0	36.2	1 120 000	-	50.0	x	x				x	
72 B - 1	4.50	114.3	68.58	72.39	44.50	103.80	105.3	147.0	161.0	46.2	1 400 000	-	65.0	x	x				x	

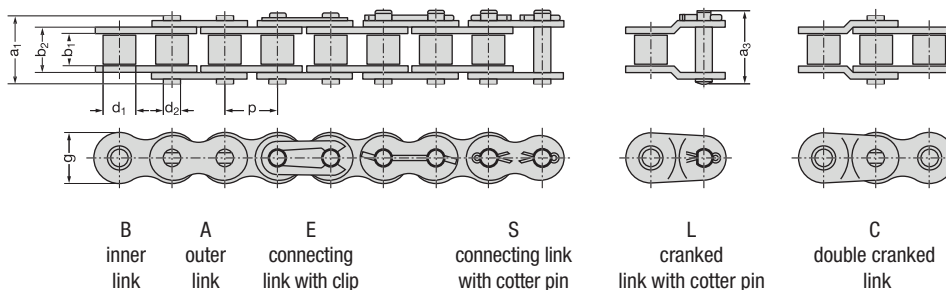

# Roller chains - European type

High Performance from Rexnord.

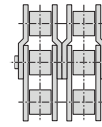

## Duplex roller chains



### Excellent Corrosion Protection

- 8-10 times better than the best competitors
- More than 100 % better in the buckling test
- Highly versatile, also suitable for aggressive environments



### Improved Wear Resistance

- 8-12 % improvement in comparison to predecessor
- Great protection through RexPro lubrication
- Long working life
- High operating reliability



### High Fatigue Resistance

- Ball-drifted plate holes
- Shot-peened chain links, seam-free rollers
- High pre-loading



### Eco friendly

- Through RexPro lubrication
- No heavy metals; Teflon- and silicone-free
- Environmental management system conforms to DIN EN ISO 14001



Rexnord meets the requirements of Machine Directive 2006/42/EC

## Duplex roller chains, ISO 606 / DIN 8187

Chain No.	Pitch		Width between inner plates	Roller diameter	Pin diameter	Width over inner link	Plate depth	Transverse pitch	Pin length	Connecting pin length	Bearing area	Required minimum tensile strength DIN/ISO	Average tensile strength	Weight	Loose parts					
	Inch	mm													A	B	C	E	L	S
	p	b <sub>1</sub> min	d <sub>1</sub> max	d <sub>2</sub> max	b <sub>2</sub> max	g	e	a <sub>1</sub> max	a <sub>3</sub> max	A	F <sub>u</sub>	F <sub>b</sub>	q							
06 B - 2	0.375	9.52	5.72	6.35	3.28	8.53	8.2	10.24	23.8	27.1	0.56	16 900	18 000	0.8			x	x	x	
08 B - 2	0.50	12.7	7.75	8.51	4.45	11.30	11.6	13.92	30.6	34.9	1.01	31 100	45 000	1.4	x	x	x	x	x	
10 B - 2	0.625	15.87	9.65	10.16	5.08	13.28	14.6	16.59	35.5	40.3	1.34	44 500	50 000	1.8	x	x	x	x	x	
12 B - 2	0.75	19.05	11.68	12.07	5.72	15.62	15.9	19.46	41.7	46.8	1.79	57 800	64 000	2.3	x	x	x	x	x	
16 B - 2	1.00	25.4	17.02	15.88	8.28	25.40	20.5	31.88	67.4	73.4	4.21	106 000	140 000	5.3	x	x	x	x	x	
20 B - 2	1.25	31.75	19.56	19.05	10.19	29.00	25.7	36.45	76.9	83.6	5.91	170 000	210 000	7.3	x	x			x	
24 B - 2	1.50	38.1	25.40	25.40	14.63	37.90	33.0	48.36	102.2	112.7	11.1	280 000	370 000	13.8	x	x			x	
28 B - 2	1.75	44.45	30.99	27.94	15.90	46.50	37.0	59.56	122.8	132.7	14.8	360 000	500 000	17.3	x	x			x	
32 B - 2	2.00	50.8	30.99	29.21	17.81	45.50	41.2	58.55	123.6	132.4	16.2	450 000	530 000	18.8	x	x			x	
40 B - 2	2.50	63.5	38.10	39.37	22.89	55.70	51.5	72.29	151.2	163.8	25.5	630 000	750 000	29.9	x	x			x	
48 B - 2	3.00	76.2	45.72	48.26	29.24	70.50	63.5	91.21	189.7	215.2	41.2	1 000 000	1 250 000	48.6	x	x			x	
56 B - 2	3.50	88.9	53.34	53.98	34.32	81.30	77.0	106.60	221.3	246.5	55.8	1 600 000	1 900 000	72.5	x	x			x	
64 B - 2	4.00	101.6	60.96	63.50	39.40	92.00	93.3	119.89	250.0	263.0	72.5	2 000 000	2 000 000	98.0	x	x			x	
72 B - 2	4.50	114.3	68.58	72.39	44.50	103.80	105.3	136.27	283.0	297.0	92.4	2 500 000	2 500 000	128.0	x	x			x	

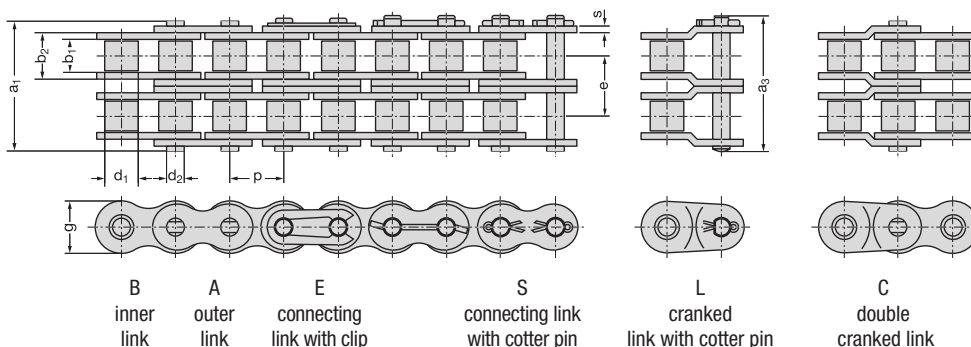

MODULE\_04/GB/2014/02 // No liability accepted for misprints or errors!





## Overview Rexnord roller chains

### Roller Chains

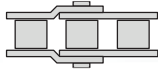

**REXNORD**

**RexPro**  
RexPro lubrication  
improved wear resistance  
high fatigue resistance

- Outstanding protection against corrosion and wear
- Unique protection against chain joint stiffness
- Extremely eco-friendly

**REXNORD**

**RexAthletic**  
good loading capacity  
extended lubrication intervals

- Durable and low-maintenance
- Longer servicing intervals
- High loading capacity

**REXNORD**

**RexCarbon**  
no lubrication  
low noise

- Maintenance-free
- Low noise
- Eco-friendly

**REXNORD**

**RexPlus**  
excellent corrosion resistance  
high reliability

- Excellent resistance to rust and acids
- Highly reliable
- Fulfills hygiene requirements
- NSF H1 certification

**REXNORD**

**RexPlusCarbon**  
no lubrication  
excellent corrosion resistance

- Combination of RexPlus and RexCarbon
- Excellent resistance to rust and acids
- Maintenance-free
- NSF H1 certification

**REXNORD**

**RexHiPro**  
good corrosion resistance  
excellent loading capacity

- Outstanding corrosion resistance
- Long service life
- High loading capacity

**Link-Belt**  
a brand of REXNORD

- The optimum choice for light and medium duty
- Good cost-benefit ratio
- High availability

**REXNORD**

**RexProX**  
RexPro lubrication  
improved wear resistance  
high fatigue resistance

- Extremely high loading capacity
- Long service life
- Outstanding protection against corrosion and wear

### Leaf Chains

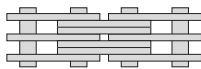

**REXNORD**

**RexPro**  
RexPro lubrication  
improved wear resistance  
high fatigue resistance

- Outstanding protection against corrosion and wear
- Unique protection against chain joint stiffness
- Extremely eco-friendly

**REXNORD**

**RexHiPro**  
good corrosion resistance  
excellent loading capacity

- Outstanding corrosion resistance
- Long service life
- High loading capacity

**REXNORD**

**RexAthletic**  
good loading capacity  
extended lubrication intervals

- Durable and low-maintenance
- Longer servicing intervals
- High loading capacity

**REXDL**  
a brand of REXNORD

- The optimum choice for light and medium duty
- Good cost-benefit ratio
- Good availability





High Performance from Rexnord

**Roller chains | American type**

**RexPro**  
RexPro lubrication  
improved wear resistance  
high fatigue resistance

kg



## Roller chains - American type

High Performance from Rexnord.

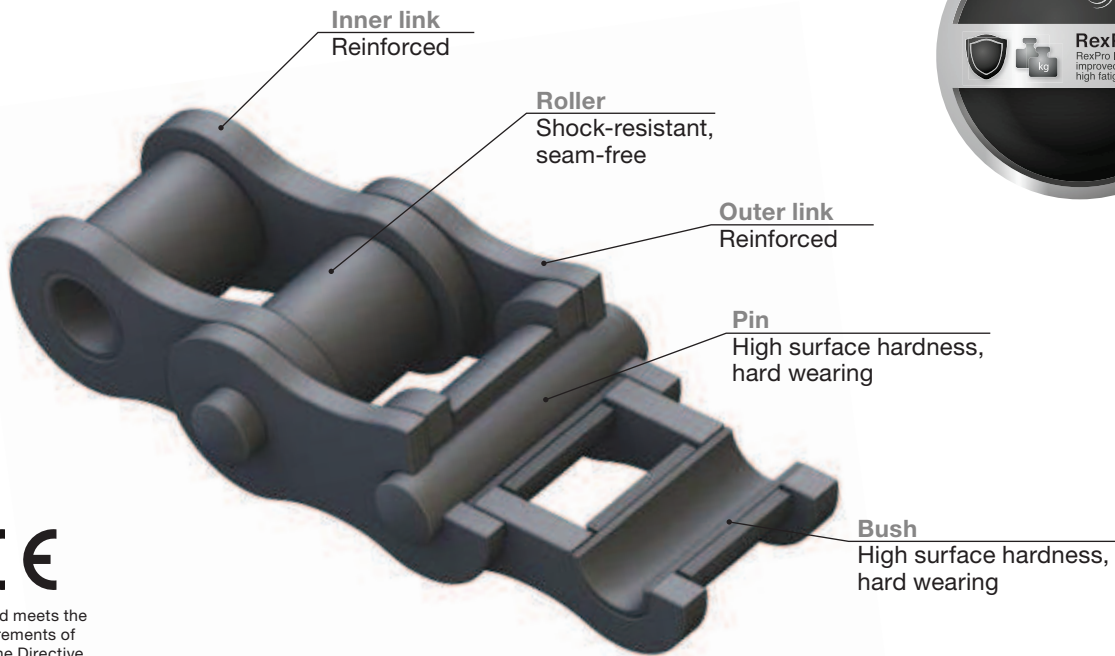

Rexnord meets the requirements of Machine Directive 2006/42/EC

### APPLICATIONS

- Automotive, textile and steel industry, bottling and beverage plants, agricultural machinery, construction machinery
- Food and confectionery industry, packing industry, conveyor engineering
- Pharmaceutical industry, paper and wood processing, machine and plant manufacturers

### CHARACTERISTICS

- High fatigue resistance
- Improved wear resistance
- Outstanding corrosion protection
- Very environmentally friendly
- Manufactured from high-performance materials
- Ball-drifted plate holes
- Seam-free rollers
- Shot-peened pins, plates, bushes and rollers
- Delivered adjusted and torsion-free on request
- NSF H2 certification, RoHS:2005 compliant

### ADVANTAGES

- Minimal bedding-in elongation
- Longer working life
- Very high impact strength
- Very robust under the toughest conditions
- Maximum operating reliability
- Improved cost-effectiveness

### LUBRICATION

- RexPro lubrication without heavy metals for improved protection
- Operating temperature: -30° C to +130° C (can be extended from -40° C to +250° C)
- Very good surface adhesion; remains drip resistant even at high temperatures
- No heavy metals, Teflon- and silicone-free

RexPro - High performance from Rexnord



**Excellent Corrosion Protection**

- 8 - 10 times better than the best competitors
- More than 100 % better in the buckling test
- Highly versatile, also suitable for aggressive environments



**Improved Wear Resistance**

- 8 - 12 % improvement in comparison to predecessor
- Great protection through RexPro lubrication
- Long working life
- High operating reliability



**High Fatigue Resistance**

- Ball-drifted plate holes
- Shot-peened chain links, seam-free rollers
- High pre-loading



**Eco friendly**

- Through RexPro lubrication
- No heavy metals; Teflon- and silicone-free
- Environmental management system conforms to DIN EN ISO 14001

Salt spray test in accordance with DIN EN ISO 9227

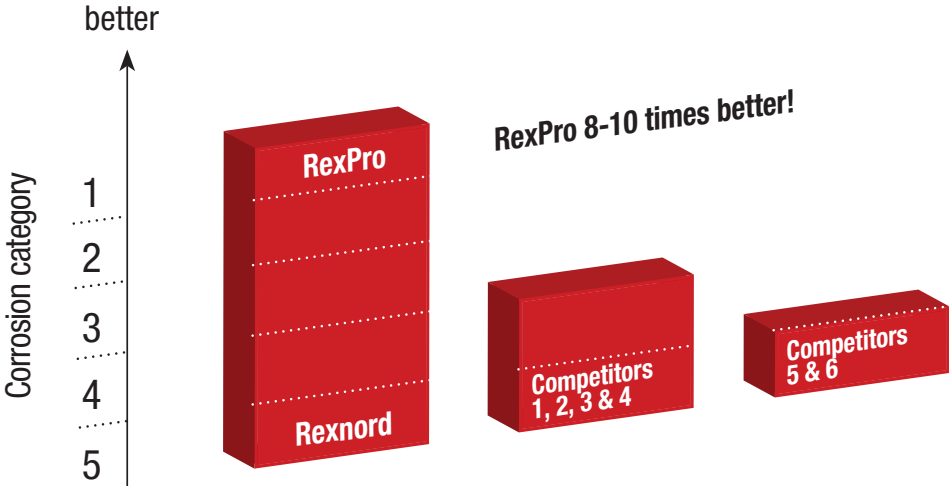

Rexnord meets the requirements of Machine Directive 2006/42/EC

## Roller chains - American type

High Performance from Rexnord.

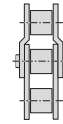

### Simplex roller chains



**CE**  
Rexnord meets the requirements of Machine Directive 2006/42/EC



#### Excellent Corrosion Protection

- 8 - 10 times better than the best competitors
- More than 100 % better in the buckling test
- Highly versatile, also suitable for aggressive environments



#### Improved Wear Resistance

- 8 - 12 % improvement in comparison to predecessor
- Great protection through RexPro lubrication
- Long working life
- High operating reliability



#### High Fatigue Resistance

- Ball-drifted plate holes
- Shot-peened chain links, seam-free rollers
- High pre-loading



#### Eco friendly

- Through RexPro lubrication
- No heavy metals; Teflon- and silicone-free
- Environmental management system conforms to DIN EN ISO 14001

## Simplex roller chains, ISO 606 / DIN 8188

Chain No.	Pitch		Width between inner plates		Roller diameter	Pin diameter	Width over inner link	Plate depth	Transverse pitch	Pin length	Connecting pin length	Bearing area	Required minimum tensile strength DIN/ISO	Average tensile strength	Weight	Loose parts									
	p	p	b <sub>1</sub> min	d <sub>1</sub> max	d <sub>2</sub> max	b <sub>2</sub> max	g	e	a <sub>1</sub> max	a <sub>3</sub> max	A	F <sub>u</sub>	F <sub>b</sub>	q	A	AK	AS	AT	B	C	E	L	S	U	
															Inch	mm	mm	mm	mm	mm	mm	mm	mm	mm	mm
40 - 1	0.50	12.7	7.85	7.95	3.96	11.15	11.6	-	16.3	21.7	0.44	13 900	20 000	0.7					x	x	x	x			
50 - 1	0.625	15.87	9.40	10.16	5.08	13.80	14.6	-	20.3	25.9	0.70	21 800	30 000	1.7	x				x	x	x	x			
60 - 1	0.75	19.05	12.57	11.91	5.94	17.70	17.7	-	25.7	31.5	1.05	31 300	40 000	1.5	x				x	x	x	x	x		
80 - 1	1.00	25.4	15.75	15.88	7.92	22.50	23.5	-	33.0	38.9	1.78	55 600	65 000	2.6	x				x	x	x	x	x		
100 - 1	1.25	31.75	18.90	19.05	9.53	27.40	29.2	-	39.4	44.9	2.61	87 000	105 000	3.8	x				x			x	x		
120 - 1	1.50	38.1	25.22	22.23	11.10	35.30	34.4	-	49.8	56.1	3.92	125 000	145 000	5.5	x				x			x	x		
140 - 1	1.75	44.45	25.22	25.40	12.70	37.00	40.8	-	53.4	59.3	4.70	170 000	220 000	7.2	x	x			x	x			x	x	
160 - 1	2.00	50.8	31.55	28.58	14.27	45.00	47.8	-	63.6	68.9	6.42	223 000	260 000	10.3	x	x			x	x			x	x	
180 - 1	2.25	57.15	35.48	35.71	17.46	50.85	50.0	-	71.3	80.0	8.87	281 000	360 000	14.0	x	x			x	x			x	x	
200 - 1	2.50	63.5	37.85	39.68	19.84	54.70	60.0	-	78.0	87.5	10.8	347 000	400 000	16.8	x				x	x			x	x	
240 - 1	3.00	76.2	47.35	47.63	23.80	67.50	70.0	-	94.8	106.7	16.1	500 000	585 000	25.0	x				x				x	x	

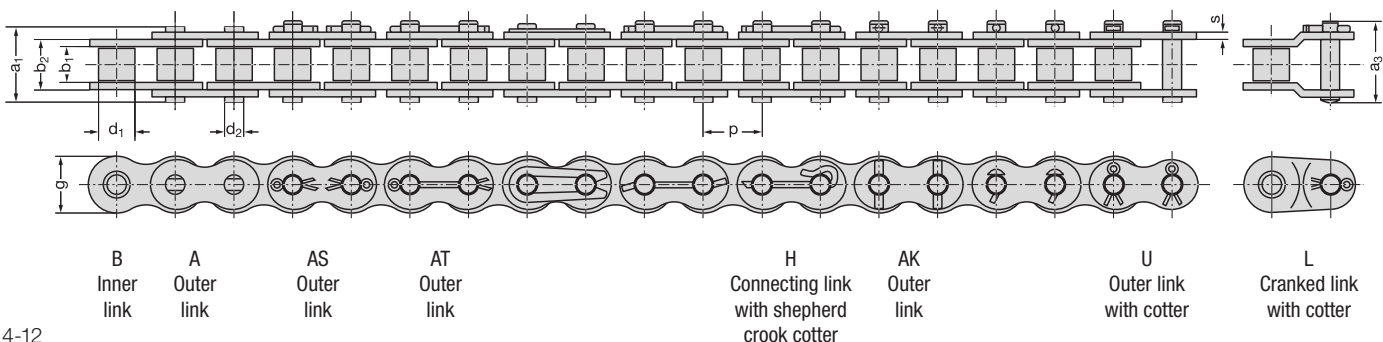

# Roller chains - American type

High Performance from Rexnord.

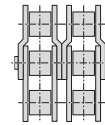

## Duplex roller chains



### Excellent Corrosion Protection

- 8 - 10 times better than the best competitors
- More than 100 % better in the buckling test
- Highly versatile, also suitable for aggressive environments



### Improved Wear Resistance

- 8 - 12 % improvement in comparison to predecessor
- Great protection through RexPro lubrication
- Long working life
- High operating reliability



### High Fatigue Resistance

- Ball-drifted plate holes
- Shot-peened chain links, seam-free rollers
- High pre-loading



### Eco friendly

- Through RexPro lubrication
- No heavy metals; Teflon- and silicone-free
- Environmental management system conforms to DIN EN ISO 14001



Rexnord meets the requirements of Machine Directive 2006/42/EC

## Duplex roller chains, ISO 606 / DIN 8188

Chain No.	Pitch		Width between inner plates		Roller diameter	Pin diameter	Width over inner link	Plate depth	Transverse pitch	Pin length	Connecting pin length	Bearing area	Required minimum tensile strength DIM/ISO	Average tensile strength	Weight	Loose parts									
	p		b <sub>1</sub> min	d <sub>1</sub> max	d <sub>2</sub> max	b <sub>2</sub> max	g	e	a <sub>1</sub> max	a <sub>3</sub> max	A	F <sub>u</sub>	F <sub>b</sub>	q	A	AK	AS	AT	B	C	E	L	S	U	
	Inch	mm	mm	mm	mm	mm	mm	mm	mm	mm	mm	cm <sup>2</sup>	N	N	kg/m										
40 - 2	0.50	12.7	7.85	7.95	3.96	11.15	11.6	14.38	30.7	36.2	0.88	27 800	40 000	1.2					x		x				
50 - 2	0.625	15.875	9.40	10.16	5.08	13.80	14.6	18.11	38.5	44.0	1.40	43 600	60 000	2.0					x	x	x				
60 - 2	0.75	19.05	12.57	11.91	5.94	17.70	17.7	22.78	48.5	54.4	2.10	62 600	80 000	2.9	x				x		x		x		
80 - 2	1.00	25.4	15.75	15.88	7.92	22.50	23.5	29.29	62.4	68.1	3.56	111 200	150 000	5.2	x				x				x		
100 - 2	1.25	31.75	18.90	19.05	9.53	27.40	29.2	35.76	75.3	87.8	5.22	174 000	220 000	7.6	x				x				x		
120 - 2	1.50	38.1	25.22	22.23	11.10	35.30	34.4	45.44	95.3	101.6	7.84	250 000	290 000	10.8	x				x				x		
140 - 2	1.75	44.45	25.22	25.40	12.70	37.00	40.8	48.87	103.3	109.6	9.40	340 000	440 000	14.2	x	x			x					x	
160 - 2	2.00	50.8	31.55	28.58	14.27	45.00	47.8	58.55	122.1	130.1	12.8	446 000	490 000	19.5	x	x			x						x
180 - 2	2.25	57.15	35.48	35.71	17.46	50.85	50.0	65.84	136.7	145.4	17.7	562 000	680 000	27.0	x	x			x						x
200 - 2	2.50	63.5	37.85	39.68	19.84	54.70	60.0	71.55	149.6	159.2	21.7	649 000	800 000	32.7	x				x	x					x
240 - 2	3.00	76.2	47.35	47.63	23.80	67.50	70.0	87.83	182.7	194.7	32.1	1 000 000	117 000	49.4	x				x	x					x

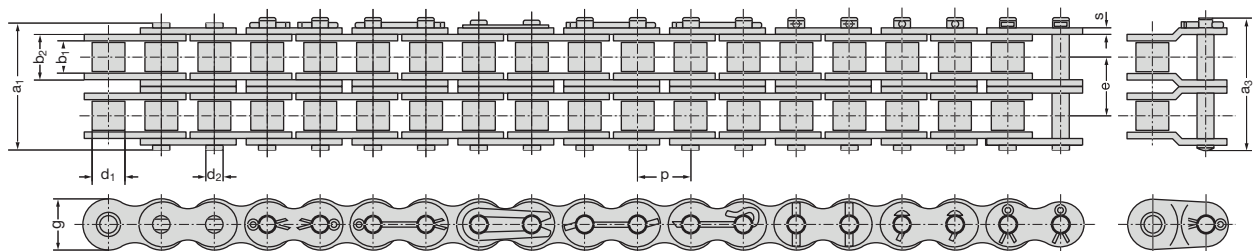

B Inner link    A Outer link    AS Outer link    AT Outer link    H Connecting link with shepherd crook cotter    AK Outer link    U Outer link with cotter    L Cranked link with cotter

## Roller chains - American type

High Performance from Rexnord.

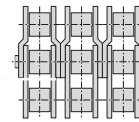

### Triplex roller chains



**CE**  
Rexnord meets the requirements of Machine Directive 2006/42/EC



#### Excellent Corrosion Protection

- 8 - 10 times better than the best competitors
- More than 100 % better in the buckling test
- Highly versatile, also suitable for aggressive environments



#### Improved Wear Resistance

- 8 - 12 % improvement in comparison to predecessor
- Great protection through RexPro lubrication
- Long working life
- High operating reliability



#### High Fatigue Resistance

- Ball-drifted plate holes
- Shot-peened chain links, seam-free rollers
- High pre-loading



#### Eco friendly

- Through RexPro lubrication
- No heavy metals; Teflon- and silicone-free
- Environmental management system conforms to DIN EN ISO 14001

## Triplex roller chains, ISO 606 / DIN 8188

Chain No.	Pitch		Width between inner plates	Roller diameter	Pin diameter	Width over inner link	Plate depth	Transverse pitch	Pin length	Connecting pin length	Bearing area	Required minimum tensile strength DIN/ISO	Average tensile strength	Weight	Loose parts											
	p	p													b <sub>1</sub> min	d <sub>1</sub> max	d <sub>2</sub> max	b <sub>2</sub> max	g	e	a <sub>1</sub> max	a <sub>3</sub> max	A	F <sub>u</sub>	F <sub>b</sub>	q
	Inch	mm	mm	mm	mm	mm	mm	mm	mm	mm	mm	cm <sup>2</sup>	N	N	kg/m											
40 - 3	0.50	12.7	7.85	7.95	3.96	11.15	11.6	14.48	45.1	50.6	1.32	41 700	60 000	1.8								x	x	x		
50 - 3	0.625	15.87	9.40	10.16	5.08	13.80	14.6	18.11	56.7	62.0	2.10	65 400	90 000	3.0	x							x	x	x		
60 - 3	0.75	19.05	12.57	11.91	5.94	17.70	17.7	22.78	71.4	77.2	3.15	93 900	120 000	4.3	x							x	x	x	x	
80 - 3	1.00	25.4	15.75	15.88	7.92	22.50	23.5	29.29	91.7	97.0	5.35	166 800	220 000	7.9	x							x	x	x	x	
100 - 3	1.25	31.75	18.90	19.05	9.53	27.40	29.2	35.76	111.1	117.2	7.83	261 000	300 000	11.4	x							x	x	x	x	
120 - 3	1.50	38.1	25.22	22.23	11.10	35.30	34.4	45.44	140.7	148.3	11.8	375 000	450 000	15.8	x							x	x	x	x	
140 - 3	1.75	44.45	25.22	25.40	12.70	37.00	40.8	48.87	151.2	158.5	14.1	510 000	660 000	21.5	x	x						x	x	x	x	x
160 - 3	2.00	50.8	31.55	28.58	14.27	45.00	47.8	58.55	180.7	188.7	19.3	669 000	790 000	26.3	x	x						x	x	x	x	x
180 - 3	2.25	57.15	35.48	35.71	17.46	50.85	50.0	65.84	202.0	210.7	26.6	843 000	1 020 000	40.5	x	x						x	x	x	x	x
200 - 3	2.50	63.5	37.85	39.68	19.84	54.70	60.0	71.55	221.1	230.7	32.6	1 041 000	1 200 000	48.8	x							x	x	x	x	x
240 - 3	3.00	76.2	47.35	47.63	23.80	67.50	70.0	87.83	270.6	282.5	48.2	1 500 000	1 930 000	74.1	x	x						x	x	x	x	x

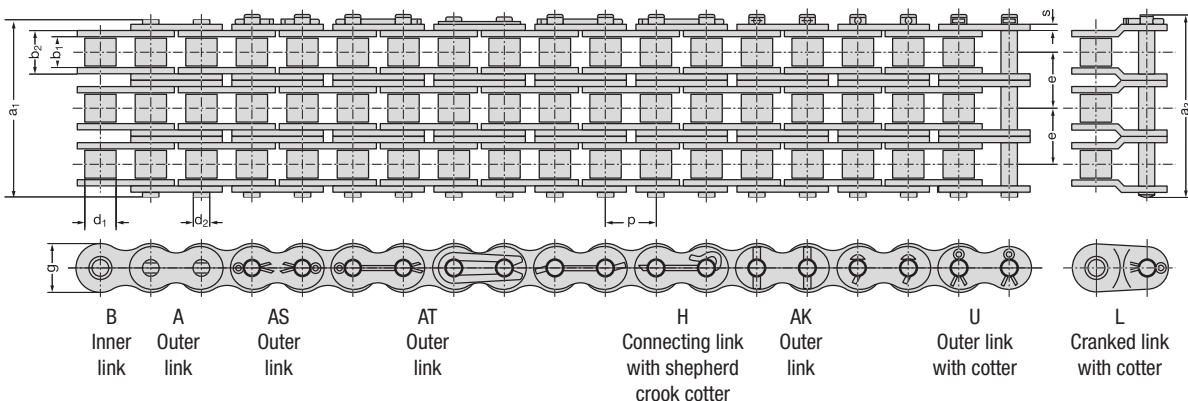



## Overview Rexnord roller chains

### Roller Chains

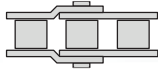

**REXNORD**  
**RexPro**  
RexPro lubrication  
improved wear resistance  
high fatigue resistance

- Outstanding protection against corrosion and wear
- Unique protection against chain joint stiffness
- Extremely eco-friendly

**REXNORD**  
**RexAthletic**  
good loading capacity  
extended lubrication intervals

- Durable and low-maintenance
- Longer servicing intervals
- High loading capacity

**REXNORD**  
**RexCarbon**  
no lubrication  
low noise

- Maintenance-free
- Low noise
- Eco-friendly

**REXNORD**  
**RexPlus**  
excellent corrosion resistance  
high reliability

- Excellent resistance to rust and acids
- Highly reliable
- Fulfills hygiene requirements
- NSF H1 certification

**REXNORD**  
**RexPlusCarbon**  
no lubrication  
excellent corrosion resistance

- Combination of RexPlus and RexCarbon
- Excellent resistance to rust and acids
- Maintenance-free
- NSF H1 certification

**REXNORD**  
**RexHiPro**  
good corrosion resistance  
excellent loading capacity

- Outstanding corrosion resistance
- Long service life
- High loading capacity

**Link-Belt**  
a brand of  
**REXNORD**

- The optimum choice for light and medium duty
- Good cost-benefit ratio
- High availability

**REXNORD**  
**RexProX**  
RexPro lubrication  
improved wear resistance  
high fatigue resistance

- Extremely high loading capacity
- Long service life
- Outstanding protection against corrosion and wear

### Leaf Chains

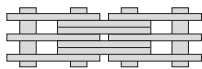

**REXNORD**  
**RexPro**  
RexPro lubrication  
improved wear resistance  
high fatigue resistance

- Outstanding protection against corrosion and wear
- Unique protection against chain joint stiffness
- Extremely eco-friendly

**REXNORD**  
**RexHiPro**  
good corrosion resistance  
excellent loading capacity

- Outstanding corrosion resistance
- Long service life
- High loading capacity

**REXNORD**  
**RexAthletic**  
good loading capacity  
extended lubrication intervals

- Durable and low-maintenance
- Longer servicing intervals
- High loading capacity

**REXDL**  
a brand of  
**REXNORD**

- The optimum choice for light and medium duty
- Good cost-benefit ratio
- Good availability





High Performance from Rexnord

**Roller chains | H-Series | American type**

**REXNORD**

**RexPro**  
RexPro lubrication  
improved wear resistance  
high fatigue resistance



## H-Series - American type

High Performance from Rexnord.

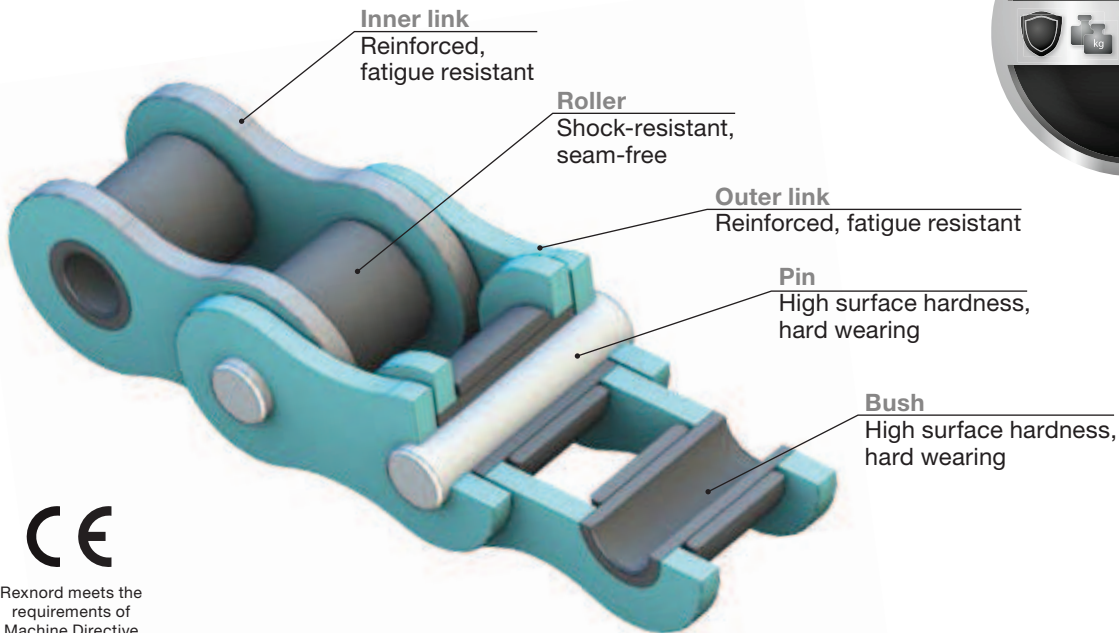

Rexnord meets the requirements of Machine Directive 2006/42/EC

### APPLICATIONS

- Drilling rigs
- Machinery for road excavation & construction
- Agriculture and forestry

### CHARACTERISTICS

- Fulfils the stringent demands set by the excellent RexPro standards
- Enlarged bearing area
- Higher breaking strength
- 40% higher fatigue resistance (loading capacity)
- Compatible with European type

### ADVANTAGES

- For high-performance power transmission
- Very high impact strength
- Very robust, even under the toughest conditions

### LUBRICATION

- RexPro lubrication without heavy metals for improved protection
- Operating temperature: -30°C to +130°C (can be extended from -40°C to + 250°C)
- Very good surface adhesion; remains drip resistant even at high temperatures
- No heavy metals; Teflon- and silicone-free

RexPro - High performance from Rexnord



- Excellent Corrosion Protection**
- 8 - 10 times better than the best competitors
  - More than 100 % better in the buckling test
  - Highly versatile, also suitable for aggressive environments



- Improved Wear Resistance**
- 8 - 12 % improvement in comparison to predecessor
  - Great protection through RexPro lubrication
  - Long working life
  - High operating reliability



- High Fatigue Resistance**
- Ball-drifted plate holes
  - Shot-peened chain links, seam-free rollers
  - High pre-loading



- Eco friendly**
- Through RexPro lubrication
  - No heavy metals; Teflon- and silicone-free
  - Environmental management system conforms to DIN EN ISO 14001

Salt spray test in accordance with DIN EN ISO 9227

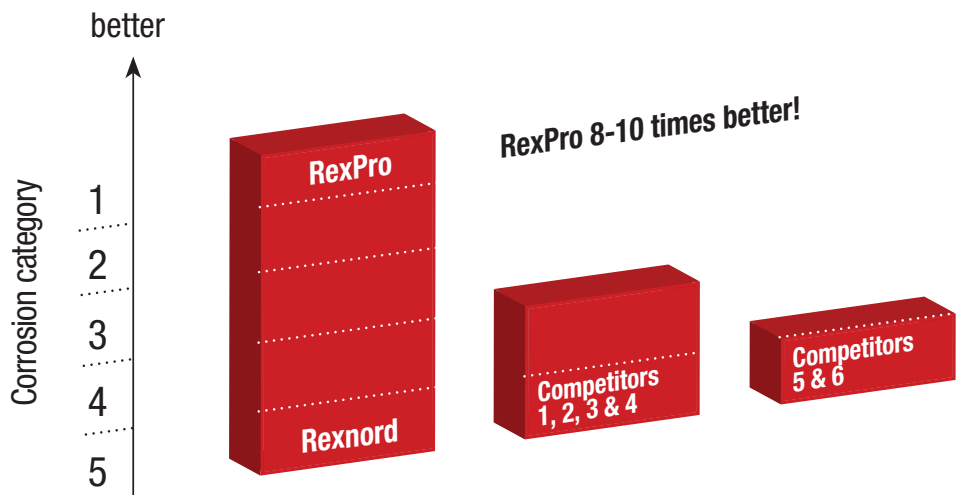

Rexnord meets the requirements of Machine Directive 2006/42/EC

## H-Series - American type

High Performance from Rexnord.

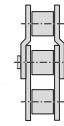

### Simplex roller chains

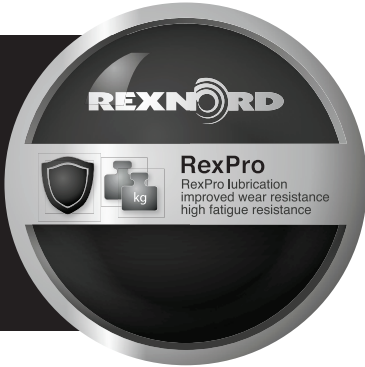

**CE**  
Rexnord meets the requirements of Machine Directive 2006/42/EC



#### Applications & Characteristics

- For heavy-duty drives and lifting purposes
- High loading capacity



#### Maintenance & Service life

- Very robust
- Long service life



#### Eco friendly

- Through RexPro lubrication
- No heavy metals; Teflon- and silicone-free
- Environmental management system conforms to DIN EN ISO 14001

## Simplex roller chains, ISO 606

Heavy Series with increased fatigue resistance (thicker plates)

Chain No.	Pitch		Width between inner plates		Roller diameter	Pin diameter	Width over inner link	Plate depth	Plate depth	Transverse pitch	Pin length	Connecting pin length	Bearing area	Required minimum tensile strength DIN/ISO	Average tensile strength	Weight	Loose parts									
	p	Inch	mm	b <sub>1</sub> min	d <sub>1</sub> max	d <sub>2</sub> max	b <sub>2</sub> max	s	g	e	a <sub>1</sub> max	a <sub>3</sub> max	A	F <sub>u</sub>	F <sub>b</sub>	q	A	B	AK	AS	AT	H	L	S	U	
																	mm	N	N	kg/m	x	x				
60 H - 1	0.75	19.05	12.57	11.91	5.94	19.35	3.05	17.7	-	28.8	32.0	1.15	31 300	45 000	2.0	x	x								x	
80 H - 1	1.00	25.4	15.75	15.88	7.92	24.30	4.0	23.5	-	35.9	41.0	1.94	55 600	80 000	3.2	x	x								x	
100 H - 1	1.25	31.75	18.90	19.05	9.53	29.00	4.7	29.2	-	42.8	48.2	2.76	87 000	45 000	4.4	x	x								x	
120 H - 1	1.50	38.1	25.22	22.23	11.10	37.00	5.5	34.4	-	53.0	59.0	4.12	125 000	150 000	6.4	x	x								x	
140 H - 1	1.75	44.45	25.22	25.40	12.70	38.70	6.3	40.8	-	56.6	62.6	4.91	170 000	207 000	8.3	x	x				x				x	x
160 H - 1	2.00	50.8	31.55	28.58	14.27	46.90	7.0	47.8	-	67.2	72.3	6.69	223 000	260 000	11.5	x	x				x				x	x
200 H - 1	2.50	63.5	37.85	39.68	19.84	57.60	9.5	60.0	-	84.0	93.5	11.4	347 000	420 000	20.0	x	x				x				x	x

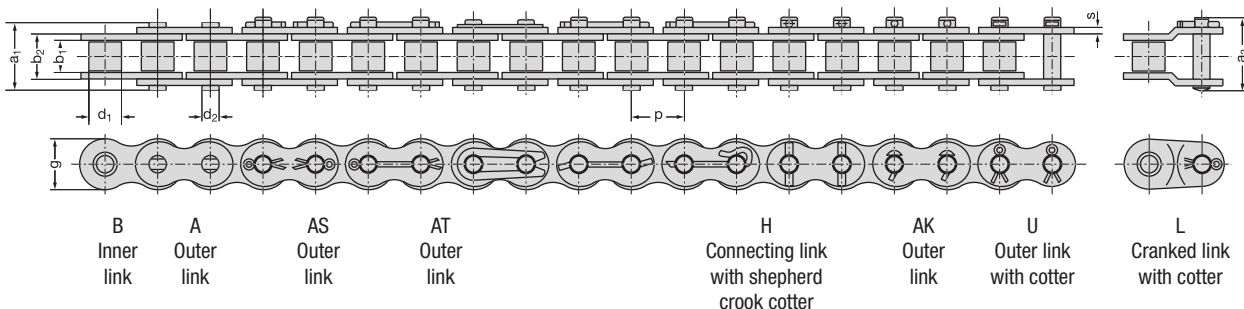

## H-Series - American type

High Performance from Rexnord.

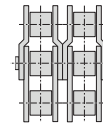

### Duplex roller chains



#### Applications & Characteristics

- For heavy-duty drives and lifting purposes
- High loading capacity



#### Maintenance & Service life

- Very robust
- Long service life



#### Eco friendly

- Through RexPro lubrication
- No heavy metals; Teflon- and silicone-free
- Environmental management system conforms to DIN EN ISO 14001



Rexnord meets the requirements of Machine Directive 2006/42/EC

**Duplex roller chains, ISO 606**  
Heavy Series with increased fatigue resistance (thicker plates)

Chain No.	Pitch		Width between inner plates	Roller diameter	Pin diameter	Width over inner link	Plate depth	Plate depth	Transverse pitch	Pin length	Connecting pin length	Bearing area	Required minimum tensile strength DIN/ISO	Average tensile strength	Weight	Loose parts											
	p															b <sub>1</sub> min	d <sub>1</sub> max	d <sub>2</sub> max	b <sub>2</sub> max	s	g	e	a <sub>1</sub> max	a <sub>3</sub> max	A	F <sub>u</sub>	F <sub>b</sub>
	Inch	mm	mm	mm	mm	mm	mm	mm	mm	mm	mm	mm	cm <sup>2</sup>	N	N	kg/m											
60 H - 2	0.75	19.05	12.57	11.91	5.94	19.35	3.05	17.7	26.10	54.9	58.0	2.30	62 600	95 000	4.0	x	x								x		
80 H - 2	1.00	25.4	15.75	15.88	7.92	24.30	4.0	23.5	32.60	68.6	73.7	3.88	112 200	100 000	6.3	x	x								x		
100 H - 2	1.25	31.75	18.90	19.05	9.53	29.00	4.7	29.2	39.12	82.0	97.8	5.52	174 000	290 000	9.0	x	x								x		
120 H - 2	1.50	38.1	25.22	22.23	11.10	37.00	5.5	34.4	48.91	101.8	109.5	8.36	250 000	300 000	12.6	x	x								x		
140 H - 2	1.75	44.45	25.22	25.40	12.70	38.70	6.3	40.8	52.20	108.7	116.0	9.82	340 000	414 000	16.2	x	x	x							x	x	
160 H - 2	2.00	50.8	31.55	28.58	14.27	46.90	7.0	47.8	61.89	128.6	136.8	13.4	446 000	520 000	22.0	x	x	x							x	x	
200 H - 2	2.50	63.5	37.85	39.68	19.84	57.60	9.5	60.0	78.30	161.6	171.2	22.8	694 000	840 000	39.0	x	x	x	x						x	x	

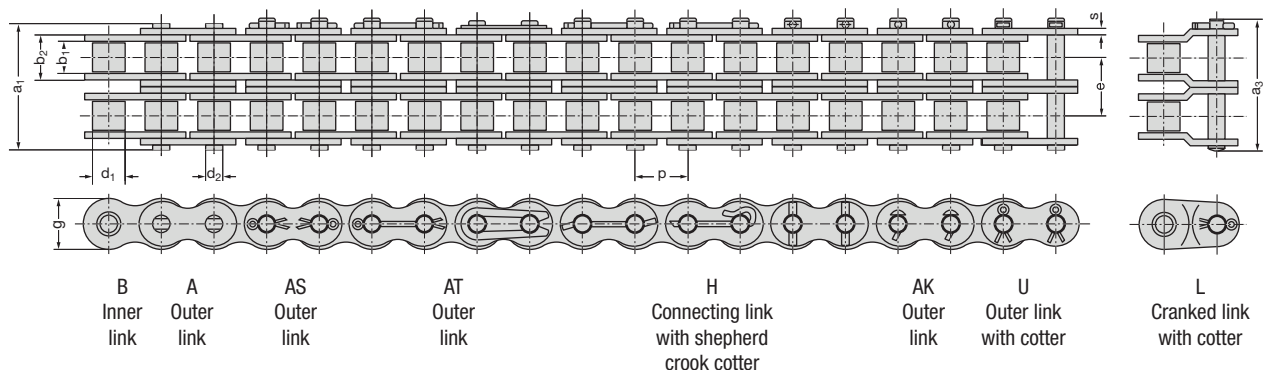

MODULE\_04/GB/2014/02 // No liability accepted for misprints or errors!

## H-Series - American type

High Performance from Rexnord.

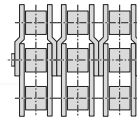

### Triplex roller chains

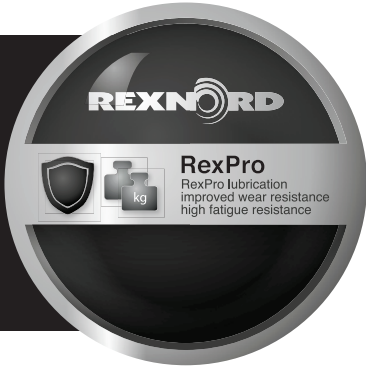

Rexnord meets the requirements of Machine Directive 2006/42/EC



### Applications & Characteristics

- For heavy-duty drives and lifting purposes
- High loading capacity



### Maintenance & Service life

- Very robust
- Long service life



### Eco friendly

- Through RexPro lubrication
- No heavy metals; Teflon- and silicone-free
- Environmental management system conforms to DIN EN ISO 14001

## Triplex roller chains, ISO 606

Heavy Series with increased fatigue resistance (thicker plates)

Chain No.	Pitch		Width between inner plates		Roller diameter	Pin diameter	Width over inner link	Plate depth	Plate depth	Transverse pitch	Pin length	Connecting pin length	Bearing area	Required minimum tensile strength DIN/ISO	Average tensile strength	Weight	Loose parts								
	p	mm	b <sub>1</sub> min	d <sub>1</sub> max	d <sub>2</sub> max	b <sub>2</sub> max	s	g	e	a <sub>1</sub> max	a <sub>3</sub> max	A	F <sub>u</sub>	F <sub>b</sub>	q	A	B	AK	AS	AT	H	L	S	U	
			Inch	mm	mm	mm	mm	mm	mm	mm	mm	mm	mm	mm	mm	mm	mm	mm	mm	mm	mm	mm	mm	mm	mm
60 H - 3	0.75	19.05	12.57	11.91	5.94	19.35	3.05	17.7	26.10	81.1	84.4	3.45	93 900	135 000	5.8	x	x							x	
80 H - 3	1.00	25.4	15.75	15.88	7.92	24.30	4.0	23.5	32.60	101.2	106.3	5.82	166 800	240 000	9.6	x	x							x	
100 H - 3	1.25	31.75	18.90	19.05	9.53	29.00	4.7	29.2	39.12	120.0	126.6	8.30	261 000	345 000	13.4	x	x							x	
120 H - 3	1.50	38.1	25.22	22.23	11.10	37.00	5.5	34.4	48.91	150.8	158.7	12.3	375 000	450 000	19.5	x	x							x	
140 H - 3	1.75	44.45	25.22	25.40	12.70	38.70	6.3	40.8	52.20	160.9	168.3	14.3	510 000	621 000	24.7	x	x	x						x	x
160 H - 3	2.00	50.8	31.55	28.58	14.27	46.90	7.0	47.8	61.89	198.0	198.7	20.1	669 000	780 000	29.4	x	x	x						x	x
200 H - 3	2.50	63.5	37.85	39.68	19.84	57.60	9.5	60.0	78.30	239.1	248.7	34.3	1 041 000	1 350 000	58.0	x	x			x				x	x

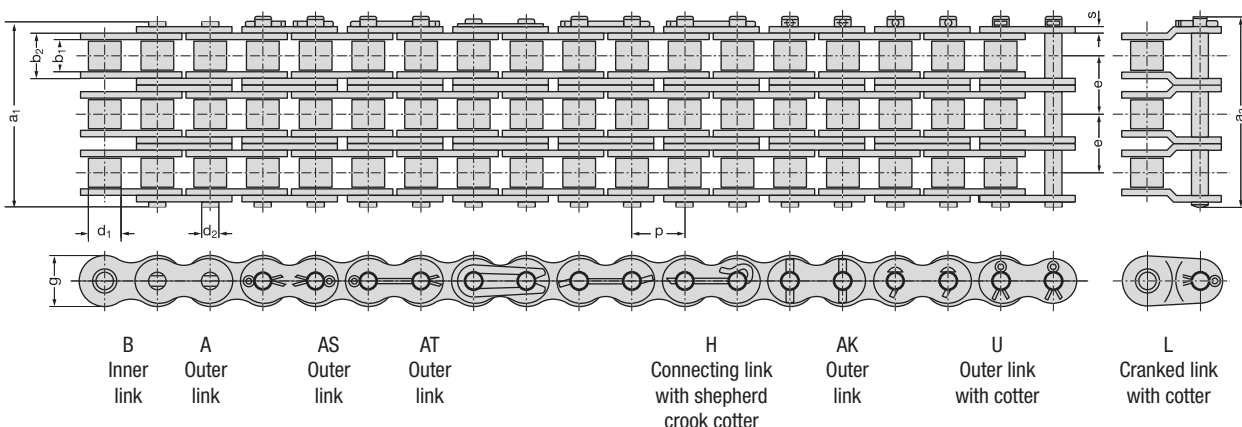



## Overview Rexnord roller chains

### Roller Chains

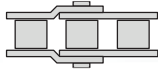

**REXNORD**

**RexPro**  
RexPro lubrication  
improved wear resistance  
high fatigue resistance

- Outstanding protection against corrosion and wear
- Unique protection against chain joint stiffness
- Extremely eco-friendly

**REXNORD**

**RexAthletic**  
good loading capacity  
extended lubrication intervals

- Durable and low-maintenance
- Longer servicing intervals
- High loading capacity

**REXNORD**

**RexCarbon**  
no lubrication  
low noise

- Maintenance-free
- Low noise
- Eco-friendly

**REXNORD**

**RexPlus**  
excellent corrosion resistance  
high reliability

- Excellent resistance to rust and acids
- Highly reliable
- Fulfills hygiene requirements
- NSF H1 certification

**REXNORD**

**RexPlusCarbon**  
no lubrication  
excellent corrosion resistance

- Combination of RexPlus and RexCarbon
- Excellent resistance to rust and acids
- Maintenance-free
- NSF H1 certification

**REXNORD**

**RexHiPro**  
good corrosion resistance  
excellent loading capacity

- Outstanding corrosion resistance
- Long service life
- High loading capacity

**Link-Belt**  
a brand of  
REXNORD

- The optimum choice for light and medium duty
- Good cost-benefit ratio
- High availability

**REXNORD**

**RexProX**  
RexPro lubrication  
improved wear resistance  
high fatigue resistance

- Extremely high loading capacity
- Long service life
- Outstanding protection against corrosion and wear

### Leaf Chains

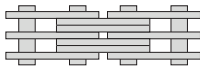

**REXNORD**

**RexPro**  
RexPro lubrication  
improved wear resistance  
high fatigue resistance

- Outstanding protection against corrosion and wear
- Unique protection against chain joint stiffness
- Extremely eco-friendly

**REXNORD**

**RexHiPro**  
good corrosion resistance  
excellent loading capacity

- Outstanding corrosion resistance
- Long service life
- High loading capacity

**REXNORD**

**RexAthletic**  
good loading capacity  
extended lubrication intervals

- Durable and low-maintenance
- Longer servicing intervals
- High loading capacity

**REXDL**  
a brand of  
REXNORD

- The optimum choice for light and medium duty
- Good cost-benefit ratio
- Good availability





High Performance from Rexnord

**Roller chains | HE-Series | American Type**

**REXNORD**

**RexPro**  
RexPro lubrication  
improved wear resistance  
high fatigue resistance

kg



**Highly  
robust**

through reinforced  
link plates and pins

## HE-Series - American type

High Performance from Rexnord.

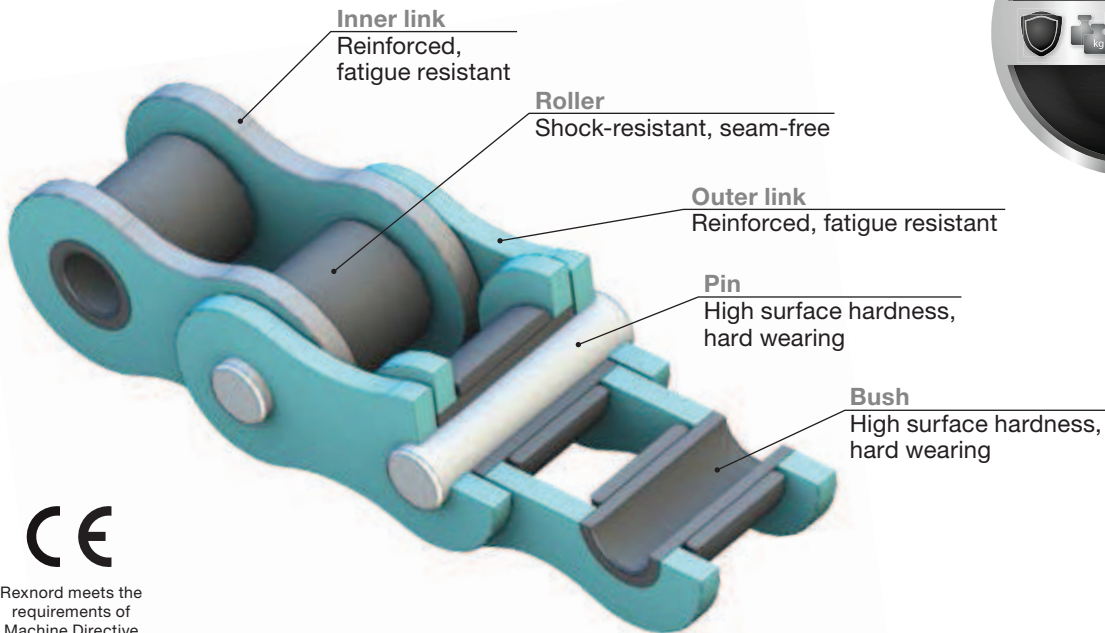

Rexnord meets the requirements of Machine Directive 2006/42/EC

### APPLICATIONS

- Drilling rigs
- Machinery for road excavation & construction
- Agriculture and forestry

### CHARACTERISTICS

- Fulfils the stringent demands set by the excellent RexPro standards
- Enlarged bearing area
- Higher breaking strength
- 40% higher fatigue resistance (loading capacity)
- Compatible with European type

### ADVANTAGES

- For high-performance power transmission
- Very high impact strength
- Very robust, even under the toughest conditions
- Optional additional wear resistance through induction hardening

### LUBRICATION

- RexPro lubrication without heavy metals for improved protection
- Operating temperature: -30°C to +130°C (can be extended from -40°C to + 250°C)
- Very good surface adhesion; remains drip resistant even at high temperatures
- No heavy metals; Teflon- and silicone-free

RexPro - High performance from Rexnord



- Excellent Corrosion Protection**
- 8 - 10 times better than the best competitors
  - More than 100 % better in the buckling test
  - Highly versatile, also suitable for aggressive environments



- Improved Wear Resistance**
- 8 - 12 % improvement in comparison to predecessor
  - Great protection through RexPro lubrication
  - Long working life
  - High operating reliability



- High Fatigue Resistance**
- Ball-drifted plate holes
  - Shot-peened chain links, seam-free rollers
  - High pre-loading



- Eco friendly**
- Through RexPro lubrication
  - No heavy metals; Teflon- and silicone-free
  - Environmental management system conforms to DIN EN ISO 14001

Salt spray test in accordance with DIN EN ISO 9227

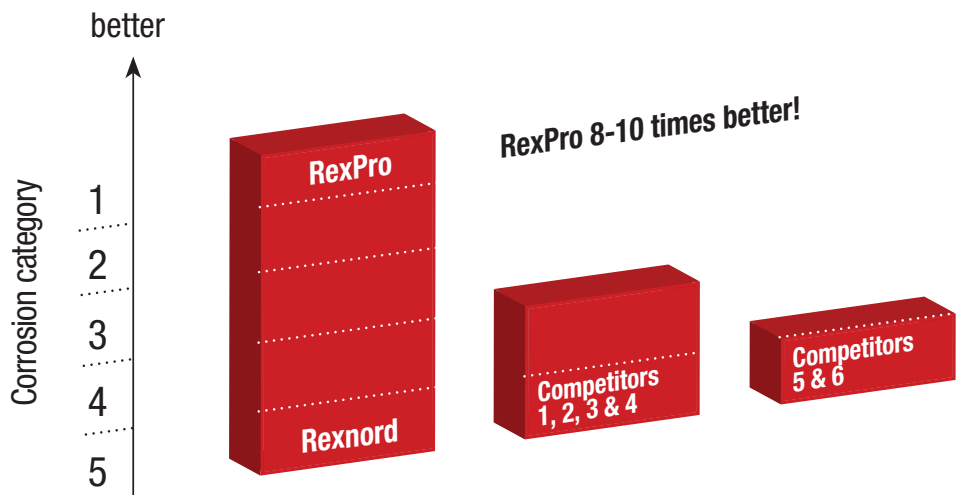

Rexnord meets the requirements of Machine Directive 2006/42/EC

## HE - Series - American type

High Performance from Rexnord.

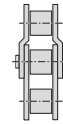

### Simplex roller chains



Rexnord meets the requirements of Machine Directive 2006/42/EC



#### Applications & Characteristics

- For heavy-duty drives and lifting purposes
- High loading capacity
- High impact strength
- Highest breaking strength



#### Maintenance & Service life

- Very robust
- Long service life



#### Eco friendly

- Through RexPro lubrication
- No heavy metals; Teflon- and silicone-free
- Environmental management system conforms to DIN EN ISO 14001

## Simplex roller chains, ISO 606

Heavy Series with increased fatigue resistance (thicker plates) and higher breaking strength

Chain No.	Pitch		Width between inner plates	Roller diameter	Pin diameter	Width over inner link	Plate depth	Plate depth	Transverse pitch	Pin length	Connecting pin length	Bearing area	Required min breaking strength DIN/ISO	Average tensile strength	Weight	Components											
	inch	mm														b <sub>1</sub> min	d <sub>1</sub> max	d <sub>2</sub> max	b <sub>2</sub> max	s	g	e	a <sub>1</sub> max	a <sub>3</sub> max	A	F <sub>u</sub>	F <sub>b</sub>
			mm	mm	mm	mm	mm	mm	mm	mm	mm	mm	cm <sup>2</sup>	N	N	kg/m											
60 HE - 1	0.75	19.05	12.57	11.91	5.94	19.35	3.05	17.7	-	28.8	32.0	1.15	42 000	56 000	2.0	x	x									x	
80 HE - 1	1.00	25.4	15.75	15.88	7.92	24.30	4.0	23.3	-	35.9	41.0	1.94	75 600	96 000	3.2	x	x									x	
100 HE - 1	1.25	31.75	18.90	19.05	9.53	29.00	4.7	29.2	-	42.8	48.2	2.76	113 400	138 000	4.4	x	x									x	
120 HE - 1	1.50	38.1	25.22	22.23	11.10	37.00	5.5	34.4	-	53.0	59.0	4.10	155 700	200 000	6.4	x	x									x	
140 HE - 1	1.75	44.45	25.22	25.40	12.70	38.70	6.3	40.8	-	56.6	62.6	4.94	209 100	250 000	8.3	x	x				x				x	x	
160 HE - 1	2.00	50.8	31.55	28.58	14.27	46.90	7.0	47.8	-	67.2	72.3	6.69	266 900	325 000	11.8	x	x				x				x	x	
200 HE - 1	2.50	63.5	37.85	39.68	19.84	57.60	9.5	60.0	-	84.0	93.5	11.4	405 000	580 000	20.0	x	x				x				x	x	

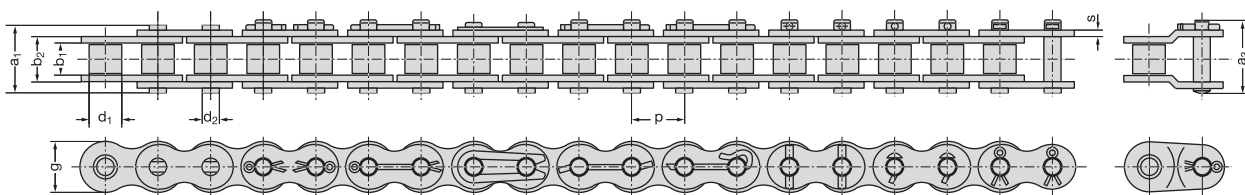

B Inner link    A Outer link    AS Outer link    AT Outer link    H Connecting link with shepherd crook cotter    AK Outer link    U Outer link with cotter    L Cranked link with cotter

## HE - Series - American type

High Performance from Rexnord.

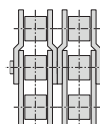

## Duplex roller chains



### Applications & Characteristics

- For heavy-duty drives and lifting purposes
- High loading capacity
- High impact strength
- Highest breaking strength



### Maintenance & Service life

- Very robust
- Long service life



### Eco friendly

- Through RexPro lubrication
- No heavy metals; Teflon- and silicone-free
- Environmental management system conforms to DIN EN ISO 14001



Rexnord meets the requirements of Machine Directive 2006/42/EC

## Duplex roller chains, ISO 606

Heavy Series with increased fatigue resistance (thicker plates) and higher breaking strength

Chain No.	Pitch		Width between inner plates	Roller diameter	Pin diameter	Width over inner link	Plate depth	Transverse pitch	Pin length	Connecting pin length	Bearing area	Required minimum tensile strength DIN/ISO	Average tensile strength	Weight	Loose parts													
	p														b <sub>1</sub> min	d <sub>1</sub> max	d <sub>2</sub> max	b <sub>2</sub> max	s	g	e	a <sub>1</sub> max	a <sub>3</sub> max	A	F <sub>c</sub>	F <sub>b</sub>	q	A
	Inch	mm	mm	mm	mm	mm	mm	mm	mm	mm	mm	mm	mm	mm	mm	mm	mm	mm	mm	mm	mm	mm	mm	mm	mm	mm	mm	mm
80 HE - 2	1.00	25.4	15.75	15.88	7.92	24.3	4.0	23.5	32.60	68.6	73.7	3.88	151 200	192 000	5.3	x	x									x		
100 HE - 2	1.25	31.75	18.90	19.05	9.53	29.0	4.7	29.2	39.12	82.0	87.8	5.52	226 800	276 000	9.0	x	x									x		
120 HE - 2	1.50	38.1	25.22	22.23	11.10	37.0	5.5	34.4	48.91	101.8	109.5	8.36	311 400	400 000	12.6	x	x									x		
140 HE - 2	1.75	44.45	25.22	25.40	12.70	38.7	6.3	40.8	52.20	108.7	116.0	9.82	418 200	500 000	15.8	x	x	x								x	x	
160 HE - 2	2.00	50.8	31.55	28.58	14.27	46.9	7.0	47.8	61.89	128.6	136.8	13.4	533 800	650 000	22.0	x	x	x								x	x	
200 HE - 2	2.50	63.5	37.85	39.68	19.84	57.6	9.5	60.0	78.30	161.6	171.2	22.8	810 000	860 000	39.0	x	x				x					x	x	

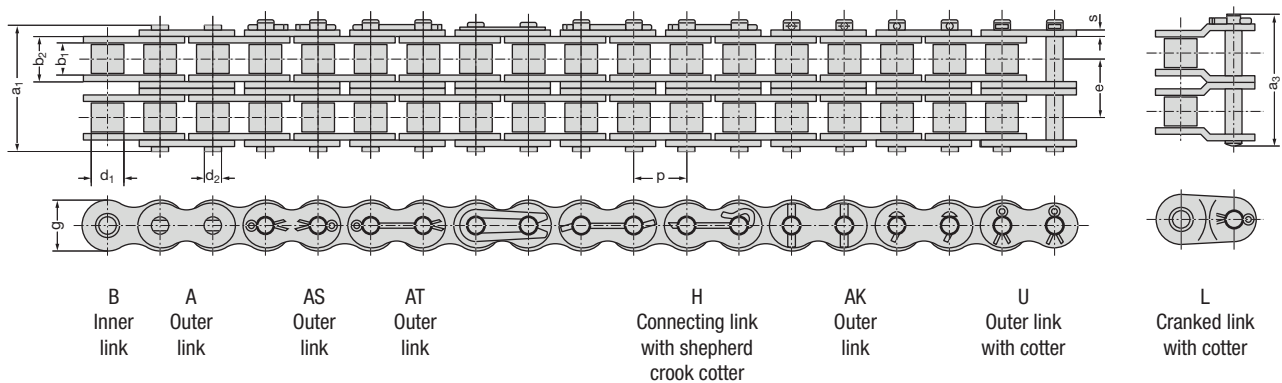

MODULE\_04/GB/2014/02 // No liability accepted for misprints or errors!

## HE - Series - American type

High Performance from Rexnord.

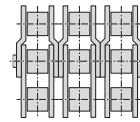

### Triplex roller chains



**CE**  
Rexnord meets the requirements of Machine Directive 2006/42/EC



#### Applications & Characteristics

- For heavy-duty drives and lifting purposes
- High loading capacity
- High impact strength
- Highest breaking strength



#### Maintenance & Service life

- Very robust
- Long service life



#### Eco friendly

- Through RexPro lubrication
- No heavy metals; Teflon- and silicone-free
- Environmental management system conforms to DIN EN ISO 14001

### Triplex roller chains, ISO 606

Heavy Series with increased fatigue resistance (thicker plates) and higher breaking strength

Chain No.	Pitch		Width between inner plates		Roller diameter	Pin diameter	Width over inner link		Plate depth	Plate depth	Transverse pitch	Pin length	Connecting pin length	Bearing area	Required min breaking strength DIN / ISO	Average tensile strength	Weight	Components								
	p	mm	b <sub>1</sub> min	d <sub>1</sub> max	d <sub>2</sub> max	b <sub>2</sub> max	s	g	e	a <sub>1</sub> max	a <sub>3</sub> max	A	F <sub>u</sub>	F <sub>b</sub>	q	A	B	AK	AS	AT	H	L	S	U		
			Inch	mm	mm	mm	mm	mm	mm	mm	mm	mm	mm	mm	mm	mm	mm	mm	mm	mm	mm	mm	mm	mm	mm	mm
80 HE - 3	1.00	25.4	15.75	15.88	7.92	24.3	4.0	23.5	32.60	101.2	106.3	5.82	226 800	288 000	9.6	x	x							x		
100 HE - 3	1.25	31.75	18.90	19.05	9.53	29.0	4.7	29.2	39.12	120.0	126.6	8.30	340 200	414 600	13.4	x	x							x		
120 HE - 3	1.50	38.1	25.22	22.23	11.10	37.0	5.5	34.4	48.91	150.8	158.7	12.3	467 100	600 000	18.5	x	x							x		
140 HE - 3	1.75	44.45	25.22	25.40	12.70	38.7	6.3	40.8	52.20	160.9	168.3	14.3	627 300	750 000	24.7	x	x	x						x	x	
160 HE - 3	2.00	50.8	31.55	28.58	14.27	46.9	7.0	47.8	61.89	198.0	198.7	20.1	800 700	975 000	29.4	x	x	x						x	x	
200 HE - 3	2.50	63.5	37.85	39.68	19.84	57.6	9.5	60.0	78.30	239.1	248.7	34.3	1215 000	1 500 000	58.0	x	x		x				x	x		

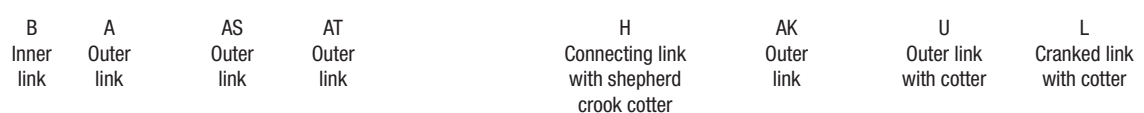
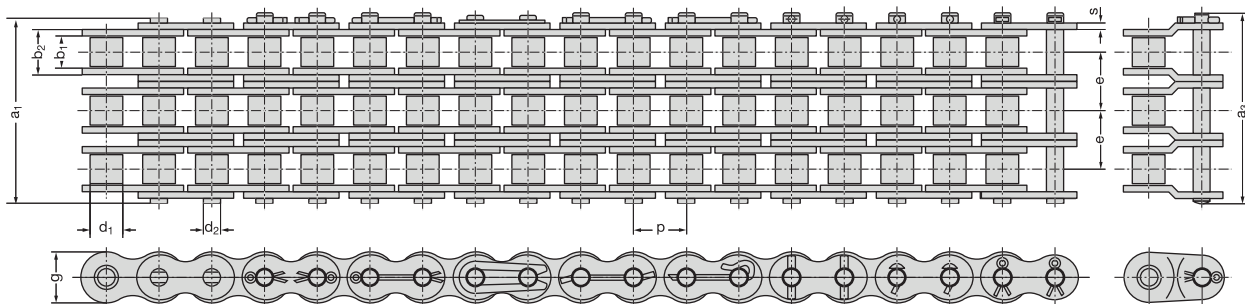



## Overview Rexnord roller chains

### Roller Chains

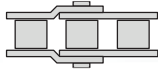

**REXNORD**

**RexPro**  
RexPro lubrication  
improved wear resistance  
high fatigue resistance

- Outstanding protection against corrosion and wear
- Unique protection against chain joint stiffness
- Extremely eco-friendly

**REXNORD**

**RexAthletic**  
good loading capacity  
extended lubrication intervals

- Durable and low-maintenance
- Longer servicing intervals
- High loading capacity

**REXNORD**

**RexCarbon**  
no lubrication  
low noise

- Maintenance-free
- Low noise
- Eco-friendly

**REXNORD**

**RexPlus**  
excellent corrosion resistance  
high reliability

- Excellent resistance to rust and acids
- Highly reliable
- Fulfills hygiene requirements
- NSF H1 certification

**REXNORD**

**RexPlusCarbon**  
no lubrication  
excellent corrosion resistance

- Combination of RexPlus and RexCarbon
- Excellent resistance to rust and acids
- Maintenance-free
- NSF H1 certification

**REXNORD**

**RexHiPro**  
good corrosion resistance  
excellent loading capacity

- Outstanding corrosion resistance
- Long service life
- High loading capacity

**Link-Belt**  
a brand of REXNORD

- The optimum choice for light and medium duty
- Good cost-benefit ratio
- High availability

**REXNORD**

**RexProX**  
RexPro lubrication  
improved wear resistance  
high fatigue resistance

- Extremely high loading capacity
- Long service life
- Outstanding protection against corrosion and wear

### Leaf Chains

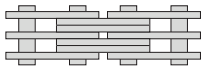

**REXNORD**

**RexPro**  
RexPro lubrication  
improved wear resistance  
high fatigue resistance

- Outstanding protection against corrosion and wear
- Unique protection against chain joint stiffness
- Extremely eco-friendly

**REXNORD**

**RexHiPro**  
good corrosion resistance  
excellent loading capacity

- Outstanding corrosion resistance
- Long service life
- High loading capacity

**REXNORD**

**RexAthletic**  
good loading capacity  
extended lubrication intervals

- Durable and low-maintenance
- Longer servicing intervals
- High loading capacity

**REXDL**  
a brand of REXNORD

- The optimum choice for light and medium duty
- Good cost-benefit ratio
- Good availability





High Performance from Rexnord

**Roller chains with straight plates**

**RexPro**  
RexPro lubrication  
improved wear resistance  
high fatigue resistance

kg



## Roller chains with straight plates

High Performance from Rexnord.

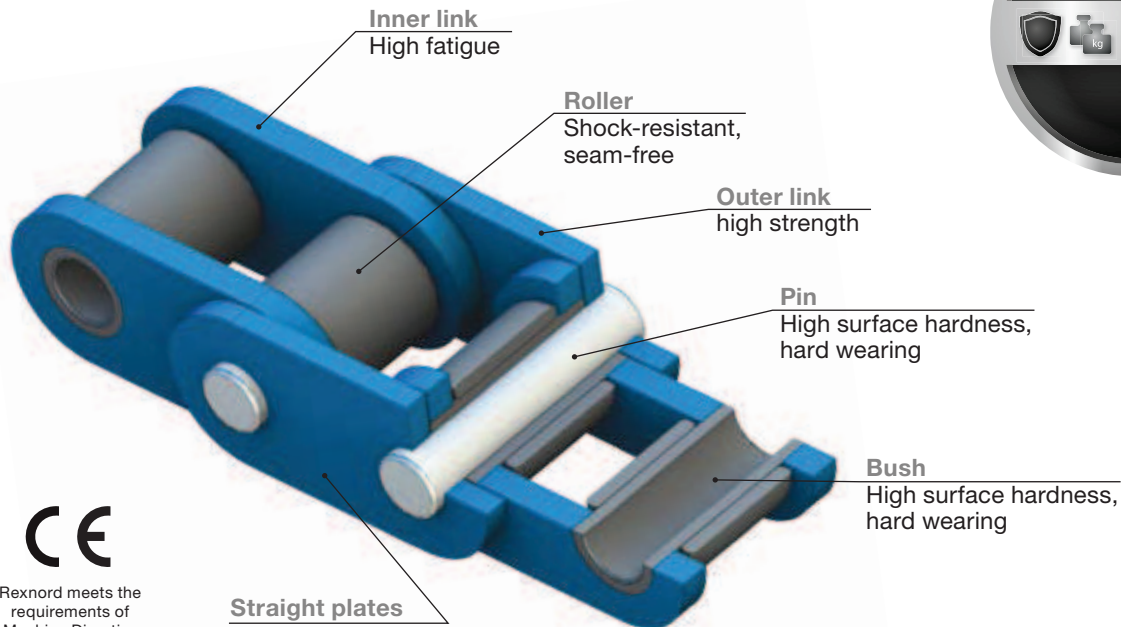

Rexnord meets the requirements of Machine Directive 2006/42/EC

### APPLICATIONS

- Automobile and steel industry, beverage and bottling plants, logistics
- Food and beverage industry, packaging industry, material handling
- Pharmaceuticals, paper and wood processing, machinery and equipment

### CHARACTERISTICS

- High fatigue resistance
- Improved wear resistance
- Outstanding corrosion protection
- Very environmentally friendly
- Manufactured from high-performance materials
- Ball-drifted plate holes
- Seam-free rollers
- Shot-peened pins, plates, bushes and rollers
- Delivered adjusted and torsion-free on request
- NSF H2 certification, RoHS:2005 compliant

### ADVANTAGES

- Minimal bedding-in elongation
- Longer working life
- Very high impact strength
- Very robust under the toughest conditions
- Maximum operating reliability
- Improved cost-effectiveness

### LUBRICATION

- RexPro lubrication without heavy metals for improved protection
- Operating temperature: -30° C to +130° C (can be extended from -40° C to +250° C)
- Very good surface adhesion; remains drip resistant even at high temperatures
- No heavy metals, Teflon- and silicone-free

RexPro - High performance from Rexnord



**Excellent Corrosion Protection**

- 8 - 10 times better than the best competitors
- More than 100 % better in the buckling test
- Highly versatile, also suitable for aggressive environments



**Improved Wear Resistance**

- 8 - 12 % improvement in comparison to predecessor
- Great protection through RexPro lubrication
- Long working life
- High operating reliability



**High Fatigue Resistance**

- Ball-drifted plate holes
- Shot-peened chain links, seam-free rollers
- High pre-loading



**Eco friendly**

- Through RexPro lubrication
- No heavy metals; Teflon- and silicone-free
- Environmental management system conforms to DIN EN ISO 14001

Salt spray test in accordance with DIN EN ISO 9227

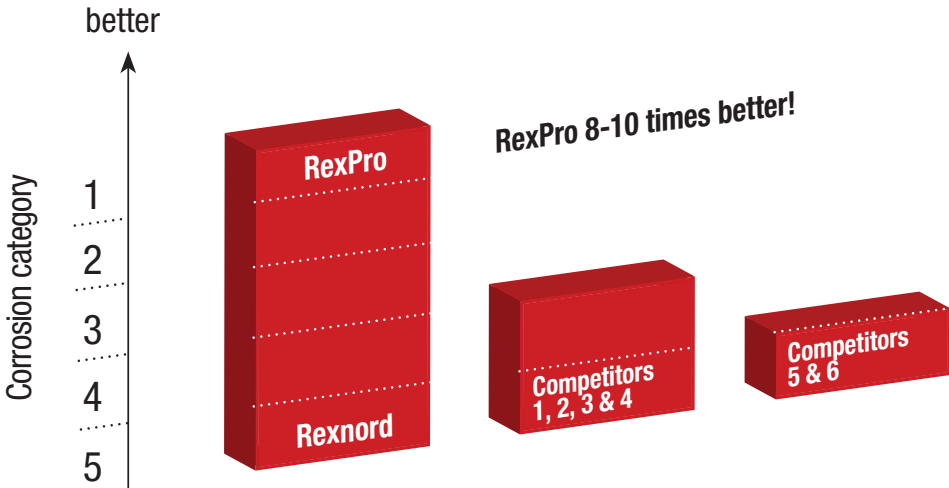

Rexnord meets the requirements of Machine Directive 2006/42/EC

## Roller chains with straight plates

High Performance from Rexnord.

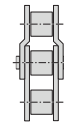

### Simplex roller chains



**CE**  
Rexnord meets the requirements of Machine Directive 2006/42/EC



#### Excellent Corrosion Protection

- 8 - 10 times better than the best competitors
- More than 100 % better in the buckling test
- Highly versatile, also suitable for aggressive environments



#### Improved Wear Resistance

- 8 - 12 % improvement in comparison to predecessor
- Great protection through RexPro lubrication
- Long working life
- High operating reliability



#### High Fatigue Resistance

- Ball-drifted plate holes
- Shot-peened chain links, seam-free rollers
- High pre-loading



#### Eco friendly

- Through RexPro lubrication
- No heavy metals; Teflon- and silicone-free
- Environmental management system conforms to DIN EN ISO 14001

## Simplex roller chains with straight plates, ISO 606 / DIN 8187 / DIN 8188

Chain No.	Pitch		Width between inner plates	Roller diameter	Pin diameter	Width over inner link	Plate depth	Transverse pitch	Pin length	Connecting pin length	Bearing area	Required minimum tensile strength DIN/ISO	Average tensile strength	Weight	Components												
	p														b <sub>1</sub> min	d <sub>1</sub> max	d <sub>2</sub> max	b <sub>2</sub> max	g	e	a <sub>1</sub> max	a <sub>3</sub> max	A	F <sub>u</sub>	F <sub>b</sub>	q	A
	Inch	mm	mm	mm	mm	mm	mm	mm	mm	mm	mm	mm	mm	mm	mm	mm <sup>2</sup>	N	N	kg/m								
06 B - 1 GL	0.375	9.525	5.72	6.35	3.28	8.53	8.1	-	12.8	15.8	0.28	9 000		0.5	x	x		x	x								
10 B - 1 GL	0.625	15.875	9.65	10.16	5.08	13.28	13.9	-	18.9	22.0	0.67	22 400		1.0	x	x		x	x								
12 B - 1 GL	0.75	19.05	11.68	12.07	5.72	15.62	15.9	-	22.3	25.1	0.89	29 000		1.3	x	x		x	x								
16 B - 1 GL	1.00	25.4	17.02	15.88	8.28	25.40	20.3	-	35.4	42.4	2.10	60 000		2.9	x	x		x	x								
20 B - 1 GL	1.25	31.75	19.56	19.05	10.19	29.00	25.8	-	40.4	47.6	2.96	95 000		4.0	x	x											
24 B - 1 GL	1.50	38.1	25.40	25.40	14.63	37.90	33.0	-	53.8	60.6	5.54	160 000		7.5	x	x											
32 B - 1 GL	2.00	50.8	30.80	29.21	17.81	45.50	41.2	-	65.1	71.0	8.10	250 000		10.4	x	x											
60 - 1 GL	0.75	19.05	12.57	11.91	5.94	17.70	18.0	-	25.7	29.6	1.05	31 800		1.6	x	x											x
80 - 1 GL	1.00	25.4	15.75	15.88	7.92	22.50	24.0	-	32.9	38.0	1.78	56 700		3.0	x	x											x

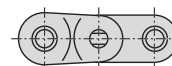
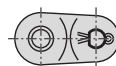
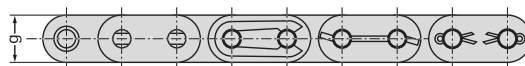
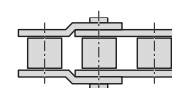
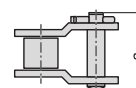
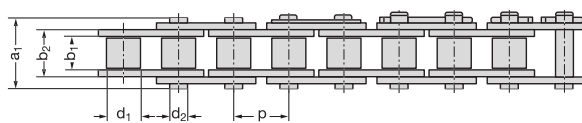

**B** inner link  
**A** outer link  
**E** connecting link with spring clip  
**G** connecting link with single wire  
**S** connecting link with cotter pin

**L** cranked link with cotter pin

**C** double cranked link

## Roller chains with straight plates

High Performance from Rexnord.

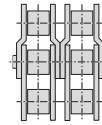

### Duplex roller chains



#### Excellent Corrosion Protection

- 8 - 10 times better than the best competitors
- More than 100 % better in the buckling test
- Highly versatile, also suitable for aggressive environments



#### Improved Wear Resistance

- 8 - 12 % improvement in comparison to predecessor
- Great protection through RexPro lubrication
- Long working life
- High operating reliability



#### High Fatigue Resistance

- Ball-drifted plate holes
- Shot-peened chain links, seam-free rollers
- High pre-loading



#### Eco friendly

- Through RexPro lubrication
- No heavy metals; Teflon- and silicone-free
- Environmental management system conforms to DIN EN ISO 14001



Rexnord meets the requirements of Machine Directive 2006/42/EC

## Duplex roller chains with straight plates, ISO 606 / DIN 8187 / DIN 8188

Chain No.	Pitch		Width between inner plates	Roller diameter	Pin diameter	Width over inner link	Plate depth	Transverse pitch	Pin length	Connecting pin length	Bearing area	Required minimum tensile strength DIN/ISO	Average tensile strength	Weight	Components						
	p														b <sub>1</sub> min	d <sub>1</sub> max	d <sub>2</sub> max	b <sub>2</sub> max	g	a <sub>1</sub> max	a <sub>3</sub> max
	Inch	mm	mm	mm	mm	mm	mm	mm	mm	mm	mm	cm <sup>2</sup>	N	N	kg/m						
06 B - 2 GL	0.375	9.525	5.72	6.35	3.28	8.53	8.1	10.24	23.1	26.0	0.56	16 000		0.8	x	x		x		x	
10 B - 2 GL	0.625	15.875	9.65	10.16	5.08	13.28	13.9	16.59	35.5	38.6	1.34	44 500		1.9	x	x		x		x	
12 B - 2 GL	0.75	19.05	11.68	12.07	5.72	15.62	15.9	19.46	41.7	44.4	1.79	57 800		2.6	x	x		x		x	
16 B - 2 GL	1.00	25.4	17.02	15.88	8.28	25.40	20.3	31.88	67.4	74.0	4.21	106 000		5.8	x	x		x		x	

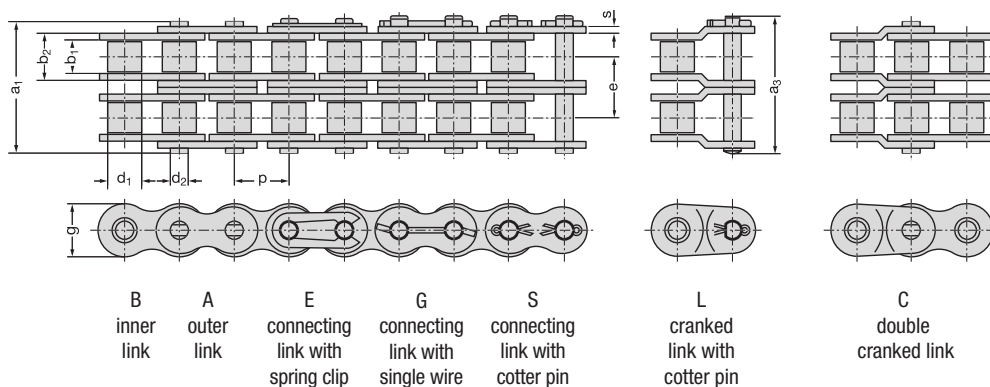

## Overview Rexnord roller chains

### Roller Chains

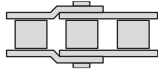

**REXNORD**  
**RexPro**  
RexPro lubrication  
improved wear resistance  
high fatigue resistance

- Outstanding protection against corrosion and wear
- Unique protection against chain joint stiffness
- Extremely eco-friendly

**REXNORD**  
**RexAthletic**  
good loading capacity  
extended lubrication intervals

- Durable and low-maintenance
- Longer servicing intervals
- High loading capacity

**REXNORD**  
**RexCarbon**  
no lubrication  
low noise

- Maintenance-free
- Low noise
- Eco-friendly

**REXNORD**  
**RexPlus**  
excellent corrosion resistance  
high reliability

- Excellent resistance to rust and acids
- Highly reliable
- Fulfills hygiene requirements
- NSF H1 certification

**REXNORD**  
**RexPlusCarbon**  
no lubrication  
excellent corrosion resistance

- Combination of RexPlus and RexCarbon
- Excellent resistance to rust and acids
- Maintenance-free
- NSF H1 certification

**REXNORD**  
**RexHiPro**  
good corrosion resistance  
excellent loading capacity

- Outstanding corrosion resistance
- Long service life
- High loading capacity

**Link-Belt**  
a brand of  
**REXNORD**

- The optimum choice for light and medium duty
- Good cost-benefit ratio
- High availability

**REXNORD**  
**RexProX**  
RexPro lubrication  
improved wear resistance  
high fatigue resistance

- Extremely high loading capacity
- Long service life
- Outstanding protection against corrosion and wear

### Leaf Chains

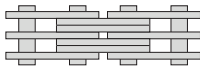

**REXNORD**  
**RexPro**  
RexPro lubrication  
improved wear resistance  
high fatigue resistance

- Outstanding protection against corrosion and wear
- Unique protection against chain joint stiffness
- Extremely eco-friendly

**REXNORD**  
**RexHiPro**  
good corrosion resistance  
excellent loading capacity

- Outstanding corrosion resistance
- Long service life
- High loading capacity

**REXNORD**  
**RexAthletic**  
good loading capacity  
extended lubrication intervals

- Durable and low-maintenance
- Longer servicing intervals
- High loading capacity

**REXDL**  
a brand of  
**REXNORD**

- The optimum choice for light and medium duty
- Good cost-benefit ratio
- Good availability



High Performance from Rexnord

**Roller chains | Factory standard**

**RexPro**  
RexPro lubrication  
improved wear resistance  
high fatigue resistance

kg

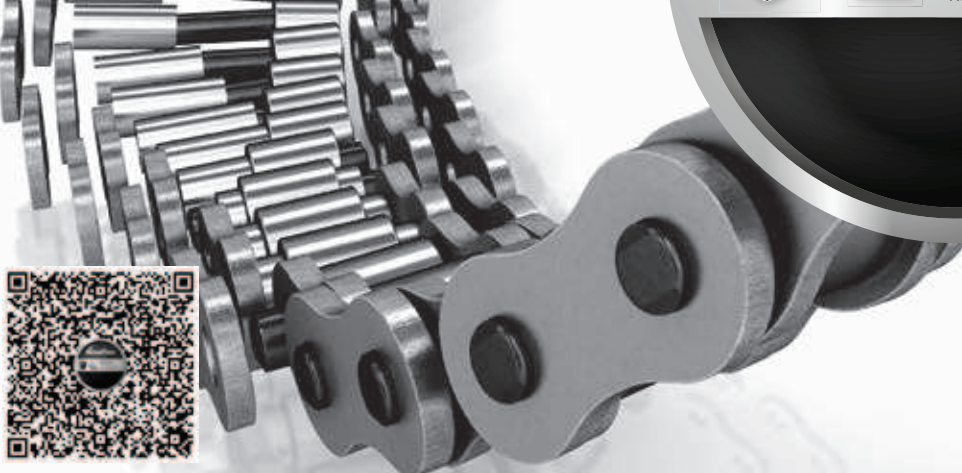

## Factory standard Roller chains

High Performance from Rexnord.

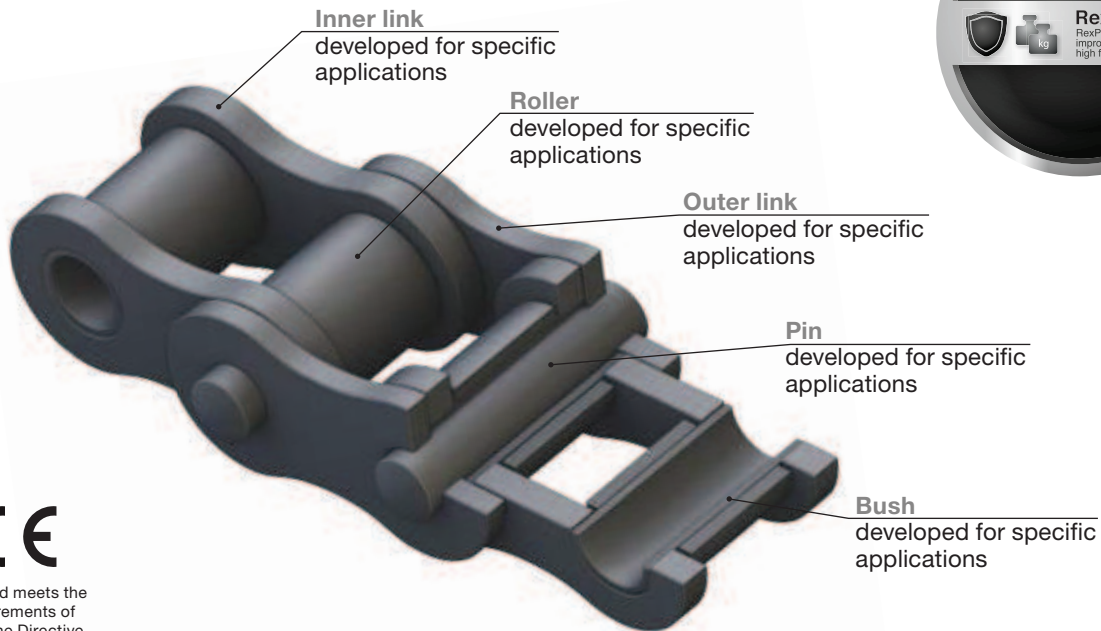

Rexnord meets the requirements of Machine Directive 2006/42/EC

### APPLICATIONS

- Drilling rigs
- Road construction
- Agriculture and forestry

### CHARACTERISTICS

- Fulfils the stringent demands set by the excellent RexPro standards
- Enlarged bearing area
- Higher breaking strength
- Highest fatigue resistance
- Compatible with European type

### ADVANTAGES

- For high-performance power transmission
- Very high impact strength
- Very robust, even under the toughest conditions

### LUBRICATION

- RexPro lubrication without heavy metals for improved protection
- Operating temperature: -30° C to +130° C (can be extended from -40° C to +250° C)
- Very good surface adhesion; remains drip resistant even at high temperatures
- No heavy metals; Teflon- and silicone-free



RexPro - High performance from Rexnord



**Excellent Corrosion Protection**

- 8 - 10 times better than the best competitors
- More than 100 % better in the buckling test
- Highly versatile, also suitable for aggressive environments



**Improved Wear Resistance**

- 8 - 12 % improvement in comparison to predecessor
- Great protection through RexPro lubrication
- Long working life
- High operating reliability



**High Fatigue Resistance**

- Ball-drifted plate holes
- Shot-peened chain links, seam-free rollers
- High pre-loading



**Eco friendly**

- Through RexPro lubrication
- No heavy metals; Teflon- and silicone-free
- Environmental management system conforms to DIN EN ISO 14001

Salt spray test in accordance with DIN EN ISO 9227

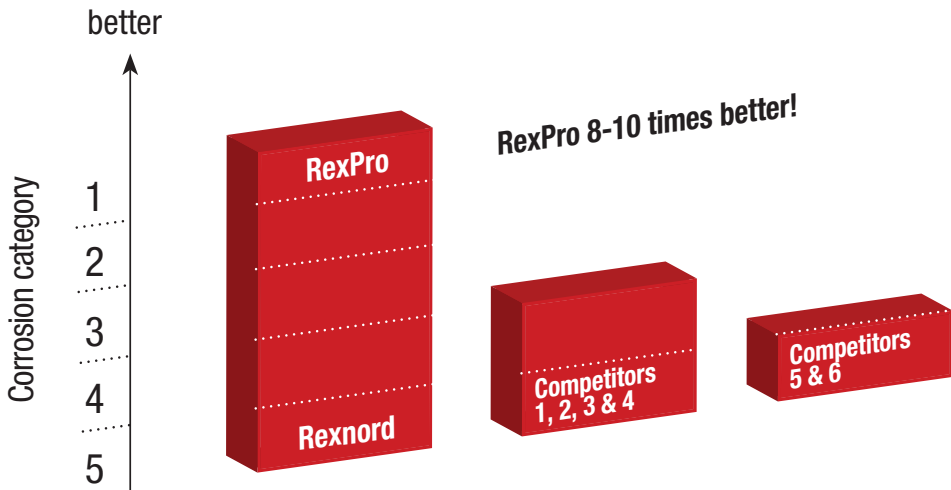

Rexnord meets the requirements of Machine Directive 2006/42/EC

## Factory standard Roller chains

Tailored solutions for specific applications.



**CE**  
 Rexnord meets the requirements of Machine Directive 2006/42/EC



### Applications & Characteristics

- For heavy-duty drives and lifting purposes
- High loading capacity



### Maintenance & Service life

- Very robust
- Long service life



### Eco friendly

- Through RexPro lubrication
- No heavy metals; Teflon- and silicone-free
- Environmental management system conforms to DIN EN ISO 14001

## Roller chains, Factory standard

Chain No.	Pitch		Width between inner plates	Roller diameter	Pin diameter	Width over inner link	Plate depth	Transverse pitch	Pin length	Locking pin length	Bearing area	Average tensile strength	Weight	Components						
	p	p												b <sub>1</sub> min	d <sub>1</sub> max	d <sub>2</sub> max	b <sub>2</sub> max	g	e	a <sub>1</sub> max
	Inch	mm	mm	mm	mm	mm	mm	mm	mm	mm	mm	cm <sup>2</sup>	N	kg/m						
Re 217	0.50	12.7	6.40	8.51	4.45	9.93	11.6	-	15.4	18.9	0.44	18 000	0.7	x	x	x	x	x		
Re 317	0.625	15.875	6.48	10.16	5.08	10.08	14.7	-	16.0	20.0	0.51	23 600	0.8	x	x	x	x	x		
Re 425	0.75	19.05	13.50	12.07	5.72	19.40	16.8	-	27.0	31.8	1.12	33 500	1.6	x	x	x	x	x	x	
Re 487	0.787	20	16.00	12.00	6.00	22.50	19.0	-	32.1	35.9	1.35	35 500	2.0	x	x	x	x	x	x	
He 488	0.787	20	16.00	12.00	8.00	22.50	19.0	-	32.5	37.3	1.80	35 500	2.0	x	x	x				
Re 514	1.00	25.4	12.70	14.00	7.00	19.07	19.7	-	27.3	33.1	1.33	45 000	1.7	x	x	x	x	x	x	
Re 516	1.00	25.4	12.70	15.88	8.28	21.07	20.6	-	30.8	37.6	1.74	63 000	2.4	x	x	x	x	x	x	
Re 525	1.00	25.4	12.70	12.70	7.00	19.07	20.8	-	27.4	32.5	1.33	45 000	1.6	x	x	x	x	x	x	
Re 626	1.18	30	17.02	15.88	8.28	25.40	20.5	-	35.5	41.9	2.10	63 000	2.3	x	x	x			x	x

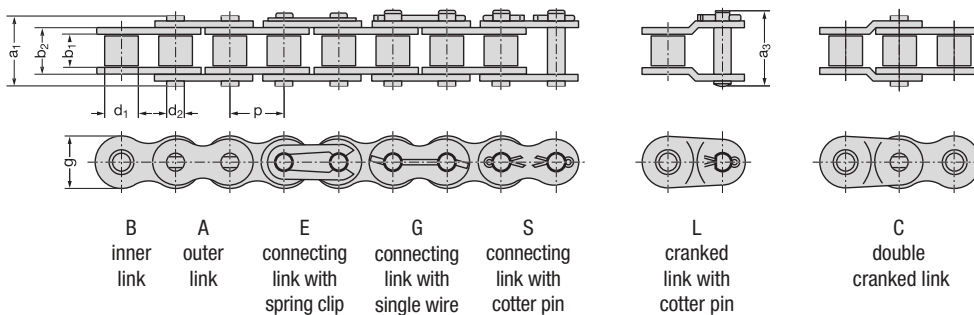



## Overview Rexnord roller chains

### Roller Chains

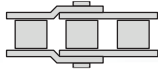

**REXNORD**  
**RexPro**  
 RexPro lubrication  
 improved wear resistance  
 high fatigue resistance

- Outstanding protection against corrosion and wear
- Unique protection against chain joint stiffness
- Extremely eco-friendly

**REXNORD**  
**RexAthletic**  
 good loading capacity  
 extended lubrication intervals

- Durable and low-maintenance
- Longer servicing intervals
- High loading capacity

**REXNORD**  
**RexCarbon**  
 no lubrication  
 low noise

- Maintenance-free
- Low noise
- Eco-friendly

**REXNORD**  
**RexPlus**  
 excellent corrosion resistance  
 high reliability

- Excellent resistance to rust and acids
- Highly reliable
- Fulfills hygiene requirements
- NSF H1 certification

**REXNORD**  
**RexPlusCarbon**  
 no lubrication  
 excellent corrosion resistance

- Combination of RexPlus and RexCarbon
- Excellent resistance to rust and acids
- Maintenance-free
- NSF H1 certification

**REXNORD**  
**RexHiPro**  
 good corrosion resistance  
 excellent loading capacity

- Outstanding corrosion resistance
- Long service life
- High loading capacity

**Link-Belt**  
 a brand of  
 REXNORD

- The optimum choice for light and medium duty
- Good cost-benefit ratio
- High availability

**REXNORD**  
**RexProX**  
 RexPro lubrication  
 improved wear resistance  
 high fatigue resistance

- Extremely high loading capacity
- Long service life
- Outstanding protection against corrosion and wear

### Leaf Chains

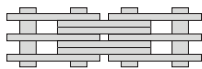

**REXNORD**  
**RexPro**  
 RexPro lubrication  
 improved wear resistance  
 high fatigue resistance

- Outstanding protection against corrosion and wear
- Unique protection against chain joint stiffness
- Extremely eco-friendly

**REXNORD**  
**RexHiPro**  
 good corrosion resistance  
 excellent loading capacity

- Outstanding corrosion resistance
- Long service life
- High loading capacity

**REXNORD**  
**RexAthletic**  
 good loading capacity  
 extended lubrication intervals

- Durable and low-maintenance
- Longer servicing intervals
- High loading capacity

**REXDL**  
 a brand of  
 REXNORD

- The optimum choice for light and medium duty
- Good cost-benefit ratio
- Good availability



High Performance from Rexnord

Plate link chains

A circular graphic with a silver border and a dark background. It contains the Rexnord logo, a shield icon, a puzzle piece icon with 'kg' below it, and the text 'RexPro' and 'RexPro lubrication improved wear resistance high fatigue resistance'.

**REXNORD**

**RexPro**  
RexPro lubrication  
improved wear resistance  
high fatigue resistance



**Highly  
robust**

through reinforced  
link plates and pins

## Plate link chains

High Performance from Rexnord.

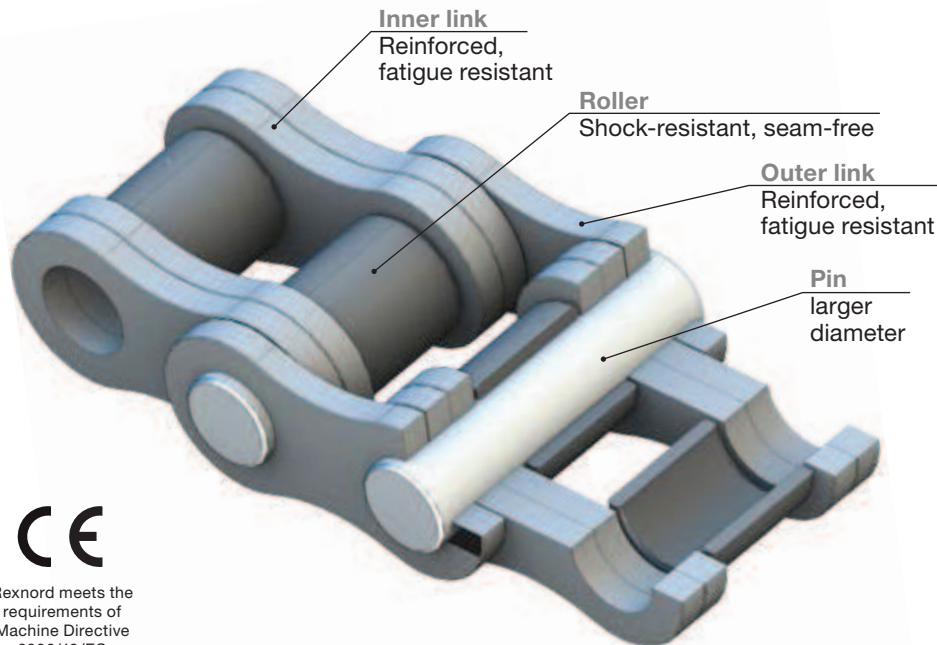

Rexnord meets the  
requirements of  
Machine Directive  
2006/42/EC

### APPLICATIONS

- Steelmaking, heavy mechanical engineering
- Special applications
- Container transport systems

### CHARACTERISTICS

- Fulfills the stringent demands set by the excellent RexPro standards
- Combines the advantages of roller chains and leaf chains
- Reinforced pins and higher breaking strength
- Double quantity of movable plate links

### ADVANTAGES

- Synchronization of lifting operations possible
- Power distribution possible via chain sprocket
- Higher operating reliability and longer service life

### LUBRICATION

- Easy relubrication
- Outstanding protection through RexPro lubrication without heavy metals
- Operating temperature: -30°C to +130°C (can be extended from -40°C to +250°C)
- Very good surface adhesion; remains drip resistant even at high temperatures
- No heavy metals; Teflon- and silicone-free

RexPro - High performance from Rexnord



- Excellent Corrosion Protection**
- 8 - 10 times better than the best competitors
  - More than 100 % better in the buckling test
  - Highly versatile, also suitable for aggressive environments



- Improved Wear Resistance**
- 8 - 12 % improvement in comparison to predecessor
  - Great protection through RexPro lubrication
  - Long working life
  - High operating reliability



- High Fatigue Resistance**
- Ball-drifted plate holes
  - Shot-peened chain links, seam-free rollers
  - High pre-loading



- Eco friendly**
- Through RexPro lubrication
  - No heavy metals; Teflon- and silicone-free
  - Environmental management system conforms to DIN EN ISO 14001

Salt spray test in accordance with DIN EN ISO 9227

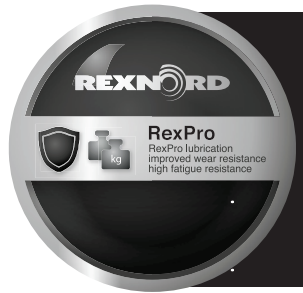
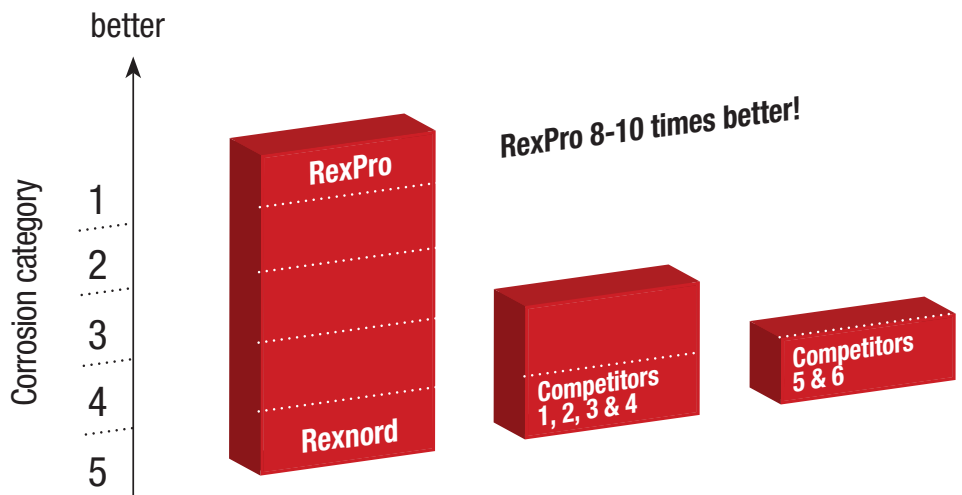

Rexnord meets the requirements of Machine Directive 2006/42/EC

MODULE\_04/GB/2014/02 // No liability accepted for misprints or errors!

## Plate link chains

High Performance from Rexnord.

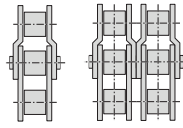

## Simplex & Duplex Plate link chains



**CE**  
Rexnord meets the requirements of Machine Directive 2006/42/EC



### Applications & Characteristics

- For heavy-duty drives and lifting purposes
- High loading capacity



### Maintenance & Service life

- Very robust
- Long service life



### Eco friendly

- Through RexPro lubrication
- No heavy metals; Teflon- and silicone-free
- Environmental management system conforms to DIN EN ISO 14001

## Simplex-Plate link chains

Chain No.	Pitch		Width between inner plates	Roller diameter	Pin diameter	Clear width outer link	Plate link thickness		Plate depth	Transverse pitch	Pin length	Bearing area	Average tensile strength	Weight	VGL-S
	p	p					s <sub>1</sub>	s <sub>2</sub>							
	Inch	mm	b <sub>1</sub> min	d <sub>1</sub> max	d <sub>2</sub> max	b <sub>3</sub> min	s <sub>1</sub>	s <sub>2</sub>	g	e	a <sub>1</sub> max	A	F <sub>b</sub>	q	
50 - 1 SL/A	2.00	50.8	31.55	28.58	20.35	57.5	6.3	6.3	47.8	-	75.5	5.1	270 000	14.9	x
64 - 1 S	2.50	63.5	38.10	39.38	30.00	77.0	9.5	9.5	59.5	-	104.0	11.4	530 000	28.0	x
64 - 1 SH	2.50	63.5	38.10	39.38	30.00	71.5	8.0	11.0	59.5	-	101.0	9.6	600 000	25.5	x
64 - 1 SHBK	2.50	63.5	27.60	39.38	30.00	67.0	9.5	11.0	59.5	-	95.0	11.4	600 000	27.5	x

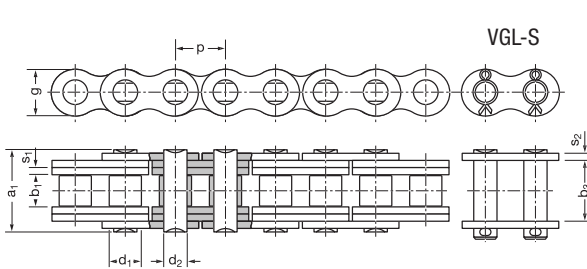

Plate link chain RLK 50-1 SL/A, Plate link chain 64-1 S / SH / SH BK

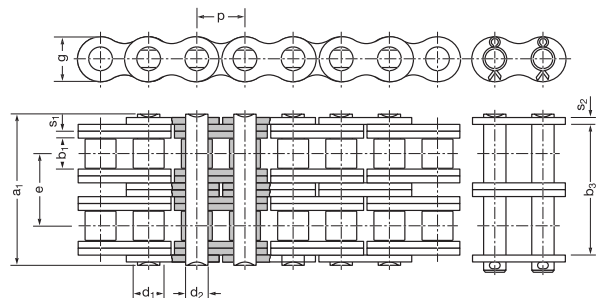

Plate link chain RLK 50-2 SL/A

## Duplex-Plate link chains

Chain No.	Pitch		Width between inner plates	Roller diameter	Pin diameter	Clear width outer link	Plate link thickness		Plate depth	Transverse pitch	Pin length	Bearing area	Average tensile strength	Weight	VGL-S
	p	p					s <sub>1</sub>	s <sub>2</sub>							
	Inch	mm	b <sub>1</sub> min	d <sub>1</sub> max	d <sub>2</sub> max	b <sub>3</sub> min	s <sub>1</sub>	s <sub>2</sub>	g	e	a <sub>1</sub> max	A	F <sub>b</sub>	q	
50 - 2 SL/A	2.00	50.8	31.55	28.58	20.35	128.0	6.3	6.3	47.8	70.5	146.0	10.2	540 000	29.4	x





## Overview Rexnord roller chains

### Roller Chains

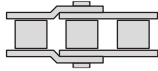

**REXNORD**  
**RexPro**  
RexPro lubrication  
improved wear resistance  
high fatigue resistance

- Outstanding protection against corrosion and wear
- Unique protection against chain joint stiffness
- Extremely eco-friendly

**REXNORD**  
**RexAthletic**  
good loading capacity  
extended lubrication intervals

- Durable and low-maintenance
- Longer servicing intervals
- High loading capacity

**REXNORD**  
**RexCarbon**  
no lubrication  
low noise

- Maintenance-free
- Low noise
- Eco-friendly

**REXNORD**  
**RexPlus**  
excellent corrosion resistance  
high reliability

- Excellent resistance to rust and acids
- Highly reliable
- Fulfills hygiene requirements
- NSF H1 certification

**REXNORD**  
**RexPlusCarbon**  
no lubrication  
excellent corrosion resistance

- Combination of RexPlus and RexCarbon
- Excellent resistance to rust and acids
- Maintenance-free
- NSF H1 certification

**REXNORD**  
**RexHiPro**  
good corrosion resistance  
excellent loading capacity

- Outstanding corrosion resistance
- Long service life
- High loading capacity

**Link-Belt**  
a brand of  
**REXNORD**

- The optimum choice for light and medium duty
- Good cost-benefit ratio
- High availability

**REXNORD**  
**RexProX**  
RexPro lubrication  
improved wear resistance  
high fatigue resistance

- Extremely high loading capacity
- Long service life
- Outstanding protection against corrosion and wear

### Leaf Chains

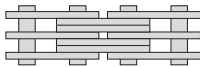

**REXNORD**  
**RexPro**  
RexPro lubrication  
improved wear resistance  
high fatigue resistance

- Outstanding protection against corrosion and wear
- Unique protection against chain joint stiffness
- Extremely eco-friendly

**REXNORD**  
**RexHiPro**  
good corrosion resistance  
excellent loading capacity

- Outstanding corrosion resistance
- Long service life
- High loading capacity

**REXNORD**  
**RexAthletic**  
good loading capacity  
extended lubrication intervals

- Durable and low-maintenance
- Longer servicing intervals
- High loading capacity

**REXDL**  
a brand of  
**REXNORD**

- The optimum choice for light and medium duty
- Good cost-benefit ratio
- Good availability



High Performance from Rexnord

## Rotary chains



**REXNORD**

**RexPro**  
RexPro lubrication  
improved wear resistance  
high fatigue resistance

  kg

## Rotary chains

High Performance from Rexnord.

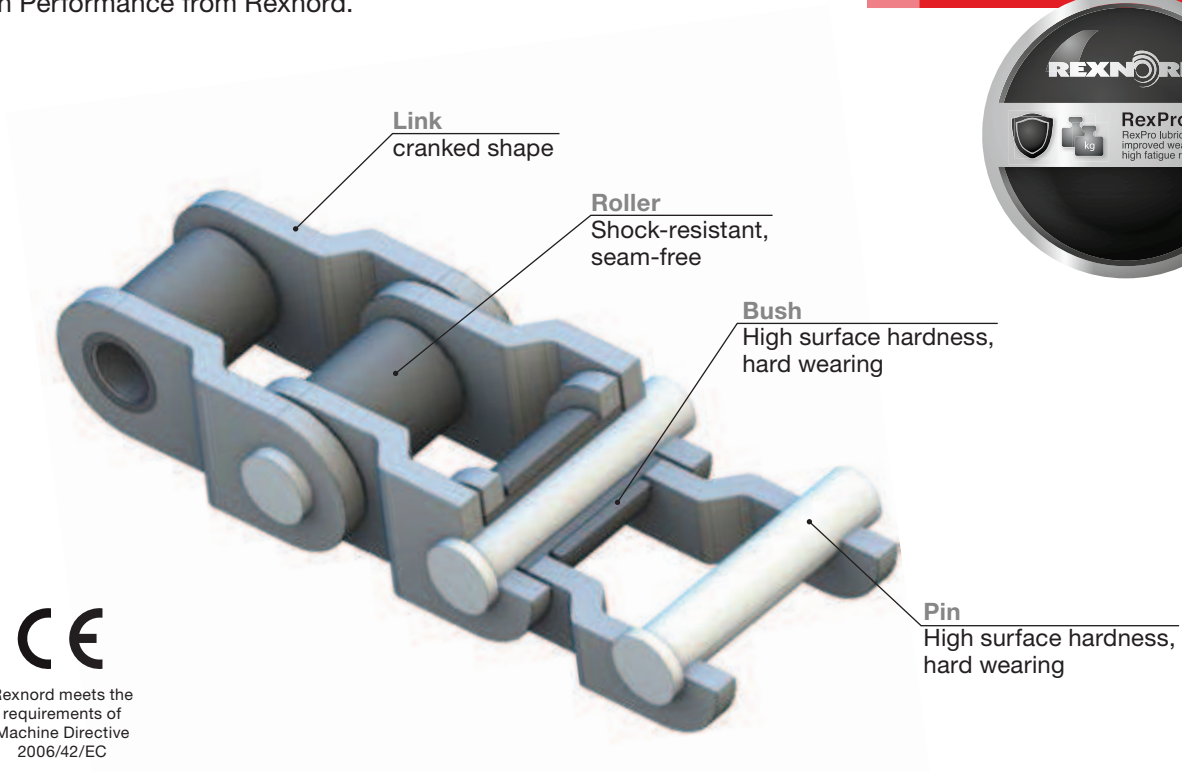

Rexnord meets the requirements of Machine Directive 2006/42/EC

### APPLICATIONS

- Drum drives
- Looped drives
- Segmented drives

### CHARACTERISTICS

- Especially robust
- Pins are torsion-proof
- Induction-hardened pins for high wear resistance

### ADVANTAGES

- Dirt-proof and shockproof
- Easy to dismantle, any pin can be removed
- Low noise
- Efficient power transmission through optimized meshing conditions

RexPro - High performance from Rexnord



**Excellent Corrosion Protection**

- 8 - 10 times better than the best competitors
- More than 100 % better in the buckling test
- Highly versatile, also suitable for aggressive environments



**Improved Wear Resistance**

- 8 - 12 % improvement in comparison to predecessor
- Great protection through RexPro lubrication
- Long working life
- High operating reliability



**High Fatigue Resistance**

- Ball-drifted plate holes
- Shot-peened chain links, seam-free rollers
- High pre-loading



**Eco friendly**

- Through RexPro lubrication
- No heavy metals; Teflon- and silicone-free
- Environmental management system conforms to DIN EN ISO 14001

Salt spray test in accordance with DIN EN ISO 9227

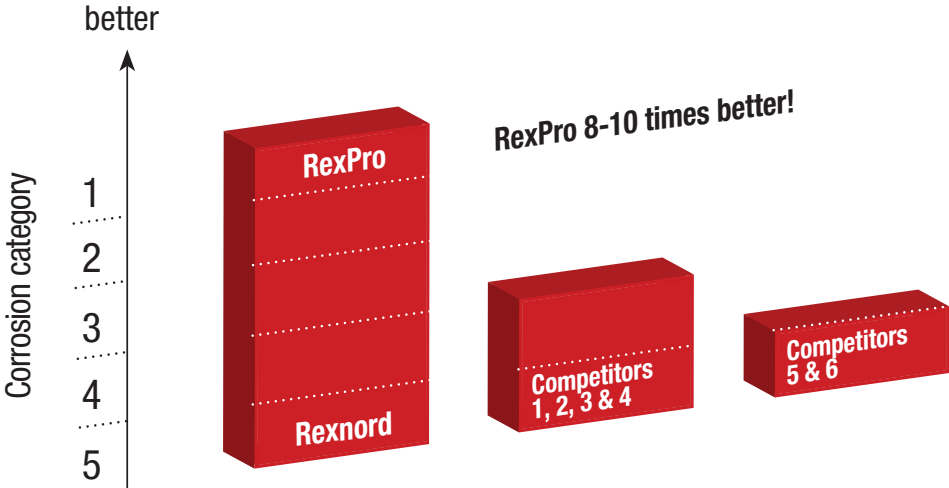

Rexnord meets the requirements of Machine Directive 2006/42/EC

## Rexnord segmented sprocket wheel system

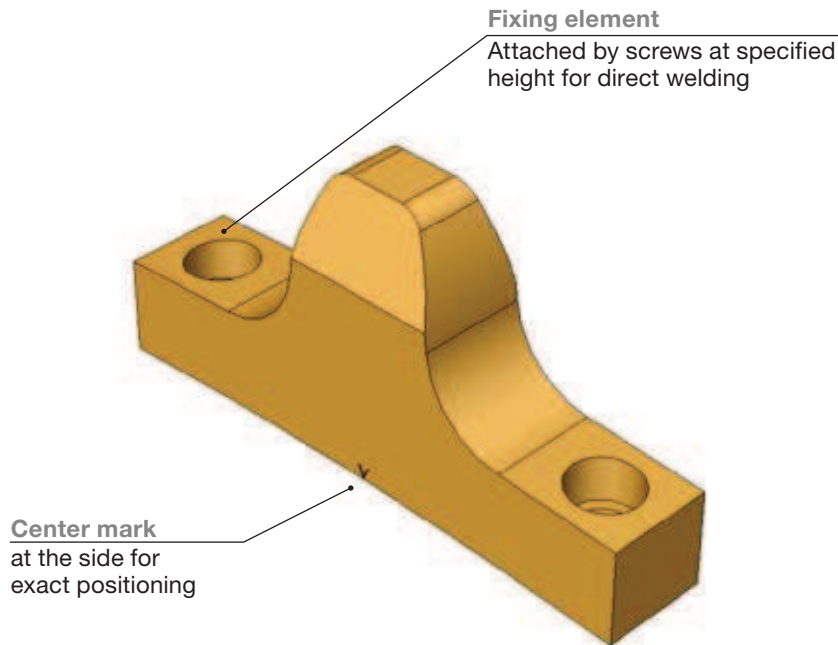

### APPLICATIONS

- Chains for drum drives
- Chains for looped drives
- Chains for segmented drives

### CHARACTERISTICS

- System consists of individual blocks of teeth
- Drum pitch circle and diameter determine height of fixing elements
- Tooth base form of tooth blocks without fixing elements are adjusted to drum radius
- Required tooth base height is determined by drum diameter, pitch and number of teeth
- Adjusted tooth blocks can be attached directly to the drum surface
- Recommended material for tooth blocks: ST 52-3
- Processed outer contour and contact surface
- Intermediate arc components produced by drum manufacturer
- Intermediate arc components with same height and width dimensions as tooth blocks
- Intermediate arc components are used to support the chain

### ADVANTAGES

- Cheaper than a large solid sprocket wheel
- Large or small tooth block clearances can be selected according to drive type
- Patented
- Tooth blocks produced in house
- Tooth blocks produced depending on application
- Optimum precision
- Functional reliability

# Rotary chains

High Performance from Rexnord.



### Applications & Characteristics

- For heavy-duty drives and lifting purposes
- High loading capacity



### Maintenance & Service life

- Very robust
- Long service life



### Eco friendly

- Through RexPro lubrication
- No heavy metals; Teflon- and silicone-free
- Environmental management system conforms to DIN EN ISO 14001



Rexnord meets the requirements of Machine Directive 2006/42/EC

## Rotary chains

Chain No.	Pitch		Width between inner plates		Roller diameter	Pin diameter		Clear width Outer link	Plate depth	Plate link thickness	Pins	Bearing area	Minimum breaking strength	Weight	Type
	Inch	mm	b <sub>1</sub> min	d <sub>1</sub> max	d <sub>2</sub> max	b <sub>3</sub> min	g	s	A	F <sub>u</sub>		q			
									cm <sup>2</sup>	N		kg/m			
Ro 20	2.00	50.8	30.6	28.58	14.27	71.5	48.0	6.35	TH	6.40	222 500	9.9	A		
Ro 20 H	2.00	50.8	30.6	28.58	15.06								A		
1037	3.075	78.1	36.5	31.75	16.46	95.2	44.5	9.5	SIH	9.40	280 400	12.8	A		
Ro 3	3.075	78.1	36.9	31.75	15.875	88.2	41.5	8.0	SIH	8.50	271 500	11.0	B		
Ro 3 B	3.067	77.9	38.5	41.28	19.05	99.3	57.5	9.5	SIH	11.2	400 500	18.0	B		
Ro 3.5	3.50	88.9	36.9	44.45	22.22	114.0	57.5	12.7	SIH	14.1	556 300	23.6	B		
Ro 4	4.063	103.2	48.0	44.45	22.22	125.1	54.0	12.7	SIH	16.6	476 200	19.4	B		
Ro 4 B	4.073	103.5	47.6	45.24	23.81	132.3	60.5	14.3	SIH	18.5	650 000	27.9	B		
Ro 4.5	4.50	114.3	50.8	57.15	27.78	136.6	76.5	14.3	CIH	22.5	894 500	32.9	B		
Ro 5 B	5.00	127.0	68.3	63.50	31.75	156.9	89.0	15.9	SIH	32.2	116 1500	52.5	B		
Ro 6	6.00	152.4	74.6	76.20	38.10	182.3	102.0	19.0	CIH	43.5	164 6500	67.1	B		

F<sub>b</sub> - breaking force • TH - hardened and tempered • SIH - partially induction hardened • CIH - induction-hardened

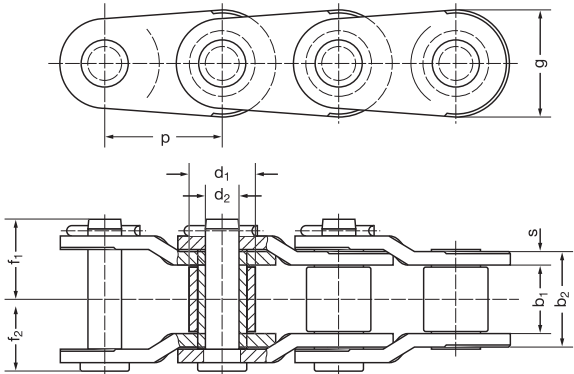

Type A

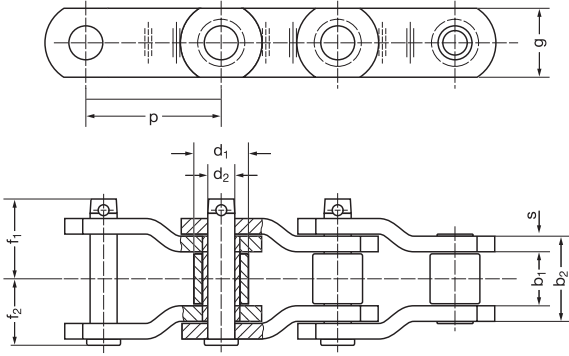

Type B

**Determination of drive type and dimensions**

Please enter your drive layout in the sketch version A, B, C or D as appropriate. However, if your planned drive solution is different from the versions illustrated, please send us a sketch with details of your proposed drive configuration. Our experienced drive engineers will be pleased to help if you have any technical questions or drive problems requiring solution. Take advantage of our wide experience in the field of drive engineering to ensure that you find the optimum drive configuration for your requirements.

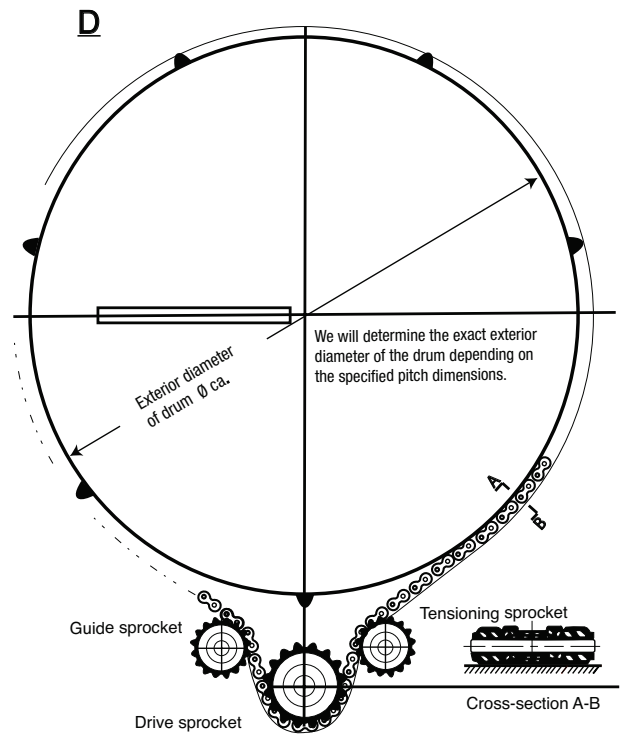
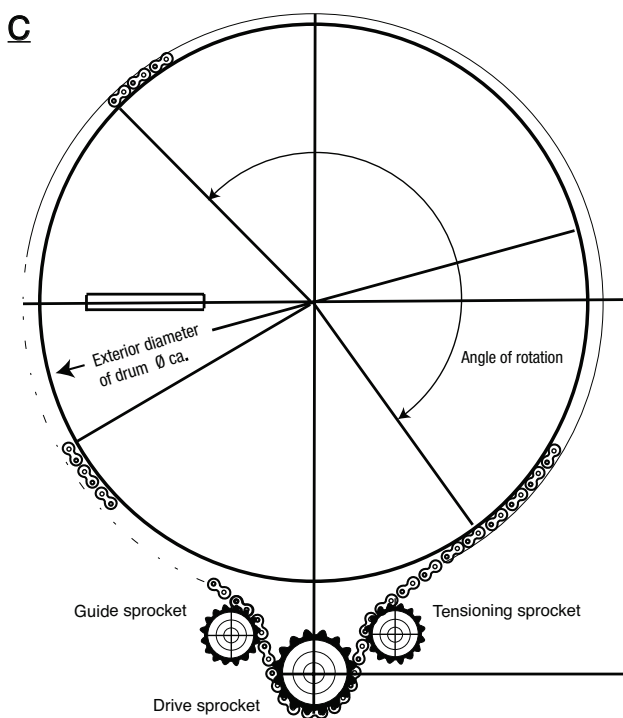
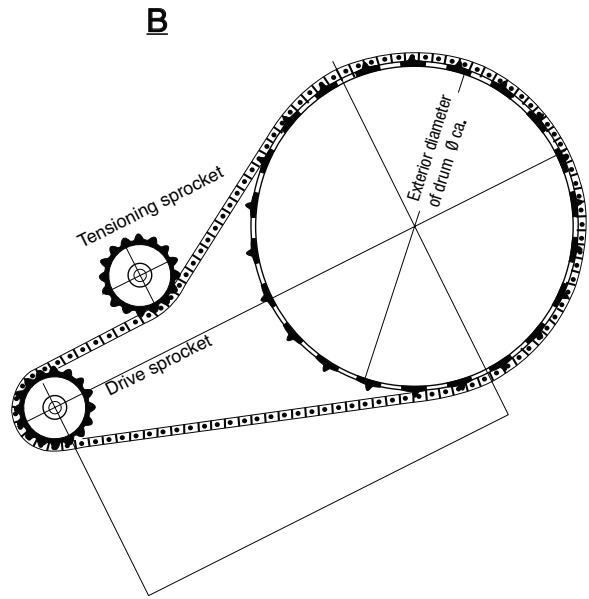
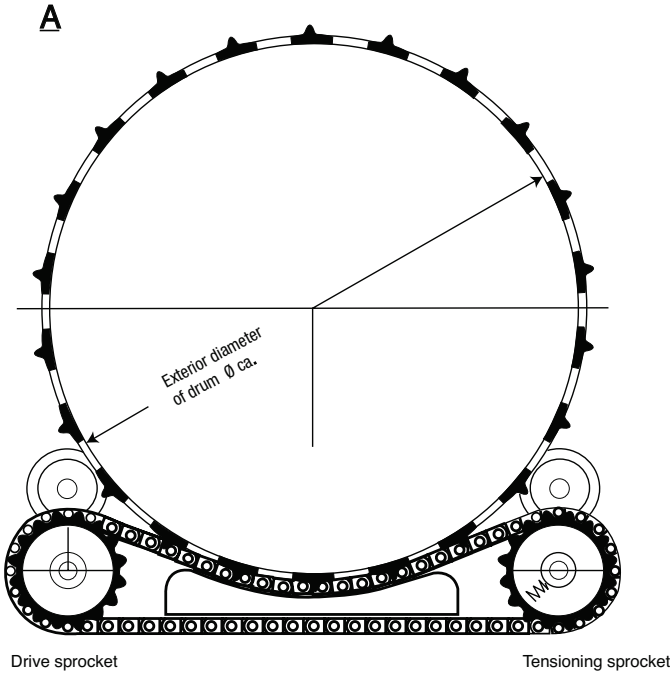



## Sprockets

Sprockets for rotary chains and roller chains with one-sided hub	Number of teeth	Pitch circle $\phi$	Tooth width	Outside $\phi$	Hub $\phi$	Pre-bore $\phi$	Bore size max	Total length	Weight approx.	Order No.
	Z	$d_0$	$B_1$	$d_K$	$d_0$	$d_2$	$d_2$	L	kg	
Ro 20 / Ro 20 H Pitch 50.8 mm	17	276.5	28	294	130	50	70	85	17	021-200-17
	19	308.7	28	327	130	50	70	85	20	021-200-19
	21	340.9	28	359	130	50	70	85	24	021-200-21
	23	373.1	28	392	140	50	75	90	29	021-200-23
Ro 3b Pitch 77.9 mm	25	405.3	28	424	140	50	75	90	33	021-200-25
	17	423.3	34	469	200	60	110	130	52	021-302-17
	19	473.3	34	520	200	60	110	130	61	021-302-19
	21	522.7	34	571	200	60	110	130	71	021-302-21
Ro 3 / Ro 3c Pitch 78.1 mm	23	572.2	34	622	200	60	110	130	83	021-302-23
	25	621.6	34	673	200	60	110	130	95	021-302-25
	17	425.0	34	469	160	60	90	110	44	021-300-17
	19	474.5	34	520	160	60	90	110	54	021-300-19
Ro 4 Pitch 103.2 mm	21	524.1	34	571	170	60	95	110	65	021-300-21
	23	573.6	34	622	170	60	95	110	79	021-300-23
	25	623.2	34	673	200	60	110	130	95	021-300-25
	17	561.6	44	616	235	70	130	155	107	021-400-17
Ro 4 1/2 Pitch 114.3 mm	19	627.0	44	684	250	70	140	170	135	021-400-19
	21	692.5	44	751	250	70	140	170	158	021-400-21
	23	758.0	44	818	250	70	140	170	184	021-400-23
	25	823.4	44	884	270	70	150	180	220	021-400-25
Ro 5 b Pitch 127.0 mm	17	622.0	47	685	270	80	150	180	147	021-450-17
	19	694.4	47	758	270	80	150	180	175	021-450-19
	21	766.9	47	830	290	80	160	190	215	021-450-21
	23	839.5	47	905	290	80	160	190	249	021-450-23
Ro 6 Pitch 152.4 mm	25	912.0	47	977	290	80	160	190	285	021-450-25
	17	691.1	63	760	310	80	170	200	231	021-502-17
	19	771.7	63	840	320	80	180	210	282	021-502-19
	21	852.2	63	920	320	80	180	210	333	021-502-21
48 B Pitch 76.2 mm	23	932.8	63	1000	320	80	180	210	389	021-502-23
	25	1013.8	63	1080	340	80	190	225	464	021-502-25
	17	829.4	69	910	360	90	200	240	370	021-600-17
	19	926.0	69	1005	360	90	200	240	442	021-600-19
56 B Pitch 88.9 mm	21	1022.6	69	1100	360	90	220	240	510	021-600-21
	23	1119.4	69	1200	360	90	220	240	598	021-600-23
	25	1216.0	69	1297	360	90	220	240	694	021-600-25
	17	414.7	41	446	235	70	130	155	85	021-076-17
48 B Pitch 76.2 mm	19	463.0	41	494	250	70	140	170	101	021-076-19
	21	511.3	41	543	250	70	140	170	111	021-076-21
	23	559.6	41	591	250	70	140	170	122	021-076-23
	25	608.0	41	644	270	70	150	180	148	021-076-25
56 B Pitch 88.9 mm	17	483.8	50.8	519	270	80	150	180	128	021-088-17
	19	540.2	50.8	575	270	80	150	180	148	021-088-19
	21	596.5	50.8	632	290	80	150	190	179	021-088-21
	23	652.9	50.8	688	290	80	150	190	198	021-088-23
25	709.3	50.8	750	290	80	150	190	228	021-088-25	

Sprockets are supplied with one-sided hub as standard. Symmetrical and asymmetrical versions available on request. Minimum strength of steel sprockets is 590 N/mm<sup>2</sup>. Tooth hardening on request.

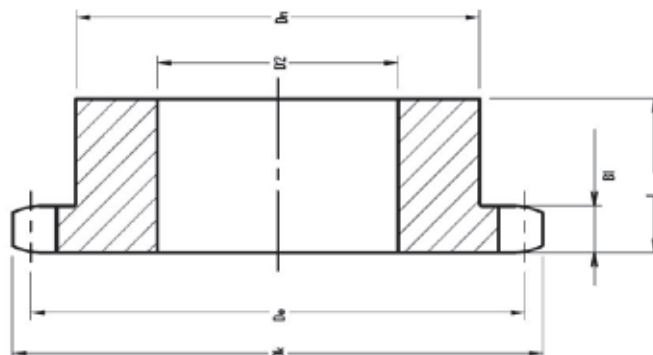

## Overview Rexnord roller chains

### Roller Chains

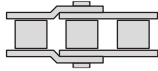

**REXNORD**  
**RexPro**  
RexPro lubrication  
improved wear resistance  
high fatigue resistance

- Outstanding protection against corrosion and wear
- Unique protection against chain joint stiffness
- Extremely eco-friendly

**REXNORD**  
**RexAthletic**  
good loading capacity  
extended lubrication intervals

- Durable and low-maintenance
- Longer servicing intervals
- High loading capacity

**REXNORD**  
**RexCarbon**  
no lubrication  
low noise

- Maintenance-free
- Low noise
- Eco-friendly

**REXNORD**  
**RexPlus**  
excellent corrosion resistance  
high reliability

- Excellent resistance to rust and acids
- Highly reliable
- Fulfills hygiene requirements
- NSF H1 certification

**REXNORD**  
**RexPlusCarbon**  
no lubrication  
excellent corrosion resistance

- Combination of RexPlus and RexCarbon
- Excellent resistance to rust and acids
- Maintenance-free
- NSF H1 certification

**REXNORD**  
**RexHiPro**  
good corrosion resistance  
excellent loading capacity

- Outstanding corrosion resistance
- Long service life
- High loading capacity

**Link-Belt**  
a brand of  
**REXNORD**

- The optimum choice for light and medium duty
- Good cost-benefit ratio
- High availability

**REXNORD**  
**RexProX**  
RexPro lubrication  
improved wear resistance  
high fatigue resistance

- Extremely high loading capacity
- Long service life
- Outstanding protection against corrosion and wear

### Leaf Chains

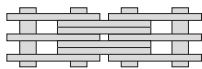

**REXNORD**  
**RexPro**  
RexPro lubrication  
improved wear resistance  
high fatigue resistance

- Outstanding protection against corrosion and wear
- Unique protection against chain joint stiffness
- Extremely eco-friendly

**REXNORD**  
**RexHiPro**  
good corrosion resistance  
excellent loading capacity

- Outstanding corrosion resistance
- Long service life
- High loading capacity

**REXNORD**  
**RexAthletic**  
good loading capacity  
extended lubrication intervals

- Durable and low-maintenance
- Longer servicing intervals
- High loading capacity

**REXDL**  
a brand of  
**REXNORD**

- The optimum choice for light and medium duty
- Good cost-benefit ratio
- Good availability



High Performance from Rexnord

Side bow roller chains



**REXNORD**

**RexPro**  
RexPro lubrication  
improved wear resistance  
high fatigue resistance

kg

## Side bow roller chains

High Performance from Rexnord.

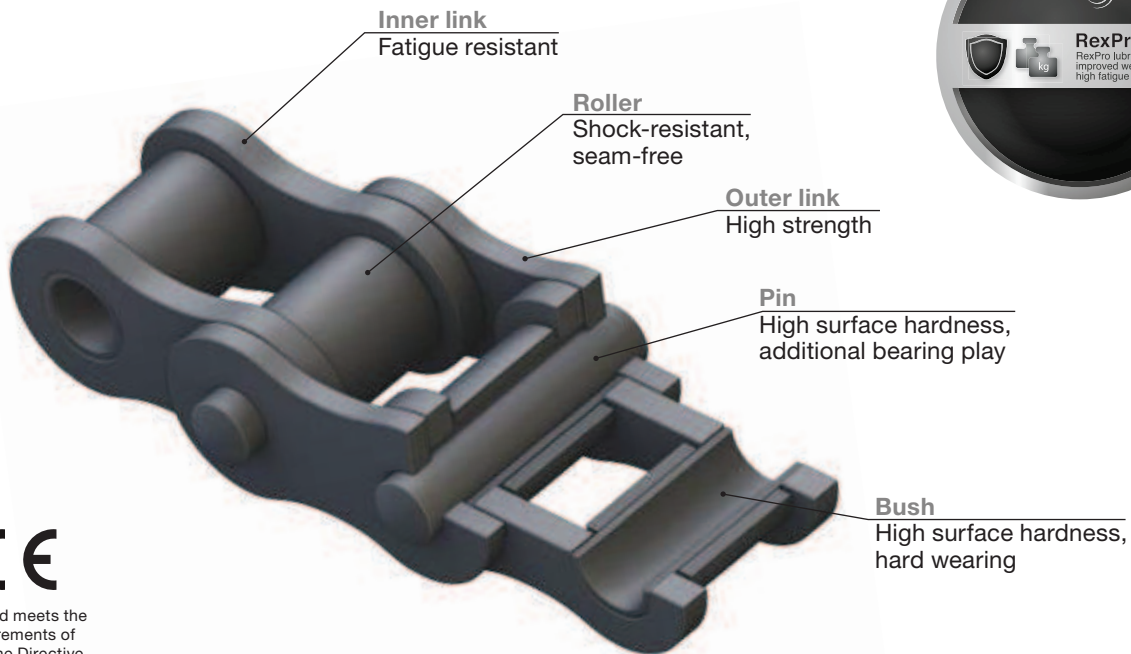

### APPLICATIONS

- Automotive industry, bottling and beverage plants, textile industry, agricultural machinery
- Food and confectionery industry, packing industry, conveyor engineering
- Pharmaceutical industry, paper and wood processing, machine and plant manufacturers

### CHARACTERISTICS

- High fatigue resistance
- Improved wear resistance
- Outstanding corrosion protection
- Very environmentally friendly
- Manufactured from high-performance materials
- Ball-drifted plate holes
- Seam-free rollers
- Shot-peened pins, plates, bushes and rollers
- Delivered adjusted and torsion-free on request
- NSF H2 certification, RoHS:2005 compliant

### ADVANTAGES

- Minimal bedding-in elongation
- Longer working life
- Very high impact strength
- Very robust under the toughest conditions
- Maximum operating reliability
- Improved cost-effectiveness

### LUBRICATION

- RexPro lubrication without heavy metals for improved protection
- Operating temperature: -30° C to +130° C (can be extended from -40° C to +250° C)
- Very good surface adhesion; remains drip resistant even at high temperatures
- No heavy metals, Teflon- and silicone-free

RexPro - High performance from Rexnord



**Excellent Corrosion Protection**

- 8 - 10 times better than the best competitors
- More than 100 % better in the buckling test
- Highly versatile, also suitable for aggressive environments



**Improved Wear Resistance**

- 8 - 12 % improvement in comparison to predecessor
- Great protection through RexPro lubrication
- Long working life
- High operating reliability



**High Fatigue Resistance**

- Ball-drifted plate holes
- Shot-peened chain links, seam-free rollers
- High pre-loading



**Eco friendly**

- Through RexPro lubrication
- No heavy metals; Teflon- and silicone-free
- Environmental management system conforms to DIN EN ISO 14001

Salt spray test in accordance with DIN EN ISO 9227

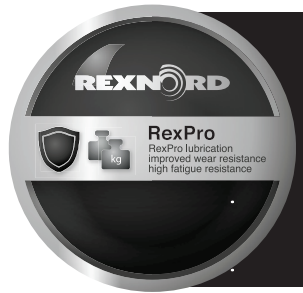
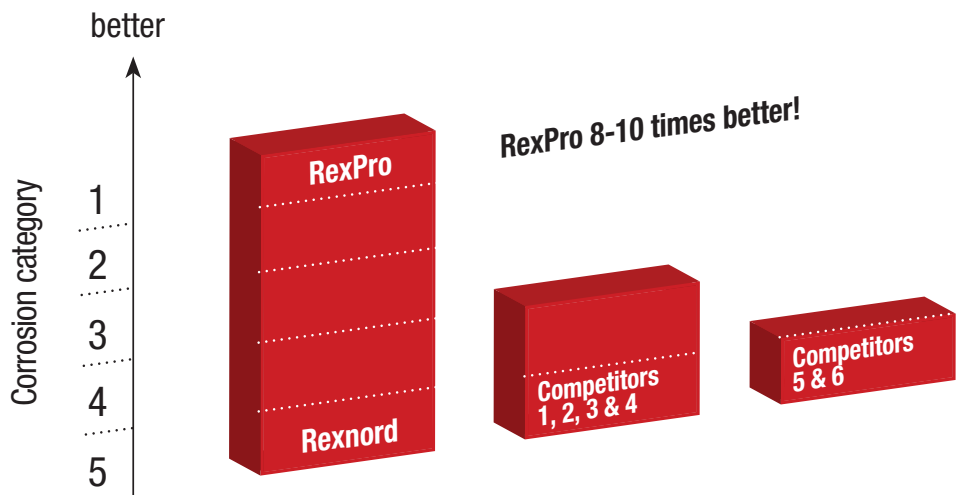

Rexnord meets the requirements of Machine Directive 2006/42/EC

## Side bow roller chains

High Performance from Rexnord.

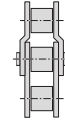

## Simplex roller chains



**CE**  
Rexnord meets the requirements of Machine Directive 2006/42/EC



### Excellent Corrosion Protection

- 8 - 10 times better than the best competitors
- More than 100 % better in the buckling test
- Highly versatile, also suitable for aggressive environments



### Improved Wear Resistance

- 8 - 12 % improvement in comparison to predecessor
- Great protection through RexPro lubrication
- Long working life
- High operating reliability



### High Fatigue Resistance

- Ball-drifted plate holes
- Shot-peened chain links, seam-free rollers
- High pre-loading



### Eco friendly

- Through RexPro lubrication
- No heavy metals; Teflon- and silicone-free
- Environmental management system conforms to DIN EN ISO 14001

## Side bow roller chains, Principal dimensions by European and American type (DIN 8187 / 8188)

Chain No.	Pitch		Width between inner plates	Roller diameter	Pin diameter	Width over inner link	Plate depth	Pin length	Connecting pin length	Radius	Stipulated min breaking load according to DIN/ISO	Weight	Components			
	p												b <sub>1</sub> min	d <sub>1</sub> max	d <sub>2</sub> max	b <sub>2</sub> max
	Inch	mm	mm	mm	mm	mm	mm	mm	mm	mm	min	N	kg/m			
08 B - 1 SB	0.50	12.7	7.75	8.51	4.45	11.30	11.8	17.1	18.3	315	11 200	0.7			x	x
10 B - 1 SB	0.625	15.875	9.65	10.16	5.08	13.28	14.7	19.4	20.6	400	15 000	0.9			x	x
12 B - 1 SB	0.75	19.05	11.68	12.07	5.72	15.61	15.9	22.5	23.7	500	20 000	1.2			x	x
63	0.75	19.05	12.80	11.91	5.08	17.60	16.8	29.1	-	356	26 000	1.4				

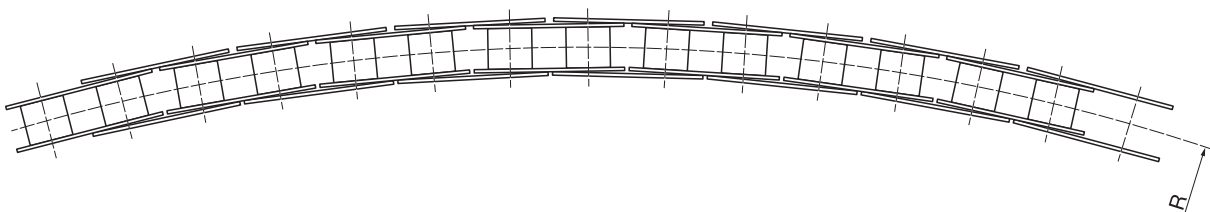
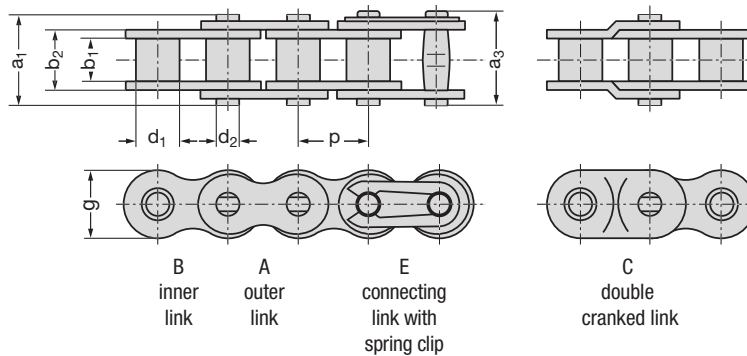



## Overview Rexnord roller chains

### Roller Chains

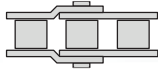

**REXNORD**

**RexPro**  
RexPro lubrication  
improved wear resistance  
high fatigue resistance

- Outstanding protection against corrosion and wear
- Unique protection against chain joint stiffness
- Extremely eco-friendly

**REXNORD**

**RexAthletic**  
good loading capacity  
extended lubrication intervals

- Durable and low-maintenance
- Longer servicing intervals
- High loading capacity

**REXNORD**

**RexCarbon**  
no lubrication  
low noise

- Maintenance-free
- Low noise
- Eco-friendly

**REXNORD**

**RexPlus**  
excellent corrosion resistance  
high reliability

- Excellent resistance to rust and acids
- Highly reliable
- Fulfills hygiene requirements
- NSF H1 certification

**REXNORD**

**RexPlusCarbon**  
no lubrication  
excellent corrosion resistance

- Combination of RexPlus and RexCarbon
- Excellent resistance to rust and acids
- Maintenance-free
- NSF H1 certification

**REXNORD**

**RexHiPro**  
good corrosion resistance  
excellent loading capacity

- Outstanding corrosion resistance
- Long service life
- High loading capacity

**Link-Belt**  
a brand of REXNORD

- The optimum choice for light and medium duty
- Good cost-benefit ratio
- High availability

**REXNORD**

**RexProX**  
RexPro lubrication  
improved wear resistance  
high fatigue resistance

- Extremely high loading capacity
- Long service life
- Outstanding protection against corrosion and wear

### Leaf Chains

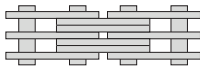

**REXNORD**

**RexPro**  
RexPro lubrication  
improved wear resistance  
high fatigue resistance

- Outstanding protection against corrosion and wear
- Unique protection against chain joint stiffness
- Extremely eco-friendly

**REXNORD**

**RexHiPro**  
good corrosion resistance  
excellent loading capacity

- Outstanding corrosion resistance
- Long service life
- High loading capacity

**REXNORD**

**RexAthletic**  
good loading capacity  
extended lubrication intervals

- Durable and low-maintenance
- Longer servicing intervals
- High loading capacity

**REXDL**  
a brand of REXNORD

- The optimum choice for light and medium duty
- Good cost-benefit ratio
- Good availability





High Performance from Rexnord

Marine diesel version



**REXNORD**

**RexPro**  
RexPro lubrication  
improved wear resistance  
high fatigue resistance

kg

A shield-shaped icon representing protection or durability.A weight icon with the letter 'kg' below it, indicating the weight of the chain link.

## Marine diesel version

High Performance from Rexnord.

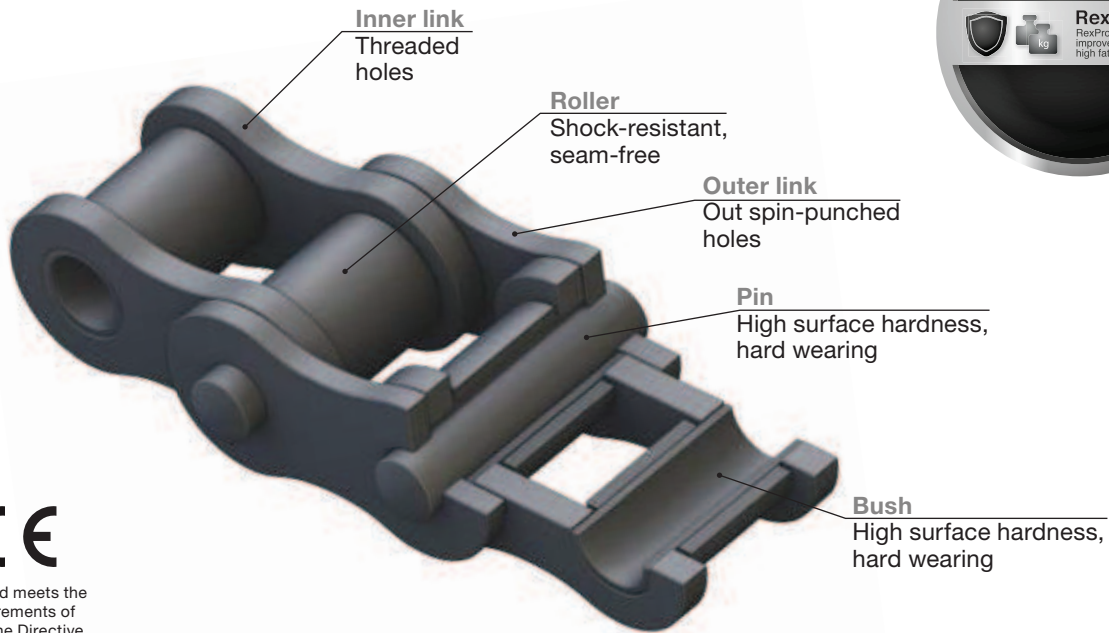

Rexnord meets the requirements of Machine Directive 2006/42/EC

### APPLICATIONS

- Steelmaking industry e.g. looping towers
- Heavy mechanical engineering
- Marine diesel timing chains

### CHARACTERISTICS

- High-precision adjustability
- Special Rexnord inner link contour for outstanding fatigue resistance
- Optimum operating reliability

### ADVANTAGES

- Suitable for use where other roller chains have reached their performance limit
- Long service life
- Optimum running-in performance

### LUBRICATION

- RexPro lubrication without heavy metals for improved protection
- Operating temperature: -30° C to +130° C (can be extended from -40° C to +250° C)
- Very good surface adhesion; remains drip resistant even at high temperatures
- No heavy metals, Teflon- and silicone-free

RexPro - High performance from Rexnord



- Excellent Corrosion Protection**
- 8 - 10 times better than the best competitors
  - More than 100 % better in the buckling test
  - Highly versatile, also suitable for aggressive environments



- Improved Wear Resistance**
- 8 - 12 % improvement in comparison to predecessor
  - Great protection through RexPro lubrication
  - Long working life
  - High operating reliability



- High Fatigue Resistance**
- Ball-drifted plate holes
  - Shot-peened chain links, seam-free rollers
  - High pre-loading



- Eco friendly**
- Through RexPro lubrication
  - No heavy metals; Teflon- and silicone-free
  - Environmental management system conforms to DIN EN ISO 14001

Salt spray test in accordance with DIN EN ISO 9227

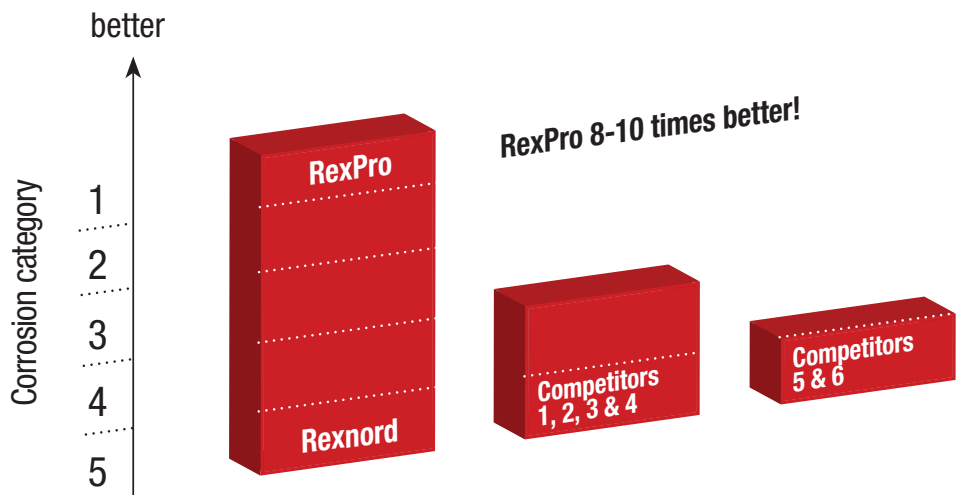

Rexnord meets the requirements of Machine Directive 2006/42/EC

Marine diesel version  
High Performance from Rexnord.

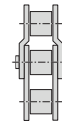

Simplex roller chains



**CE**  
Rexnord meets the requirements of Machine Directive 2006/42/EC



### Excellent Corrosion Protection

- 8 - 10 times better than the best competitors
- More than 100 % better in the buckling test
- Highly versatile, also suitable for aggressive environments



### Improved Wear Resistance

- 8 - 12 % improvement in comparison to predecessor
- Great protection through RexPro lubrication
- Long working life
- High operating reliability



### High Fatigue Resistance

- Ball-drifted plate holes
- Shot-peened chain links, seam-free rollers
- High pre-loading



### Eco friendly

- Through RexPro lubrication
- No heavy metals; Teflon- and silicone-free
- Environmental management system conforms to DIN EN ISO 14001

## Simplex roller chains, ISO 606 / DIN 8187 (Marine-Diesel)

Chain No.	Pitch		Width between inner plates	Roller diameter	Pin diameter	Width over inner link	Plate depth	Transverse pitch	Pin length	Bearing area	Required minimum breaking strength DIN/ISO	Weight
	p											
	Inch	mm	b <sub>1</sub> min	d <sub>1</sub> max	d <sub>2</sub> max	b <sub>2</sub> max	g	a <sub>1</sub> max	a <sub>3</sub> max	A	F <sub>u</sub>	q
32 B - 1 M	2.00	50.8	30.99	29.21	17.81	45.5	41.2	-	65.1	8.10	250 000	9.5
40 B - 1 M	2.50	63.5	38.10	39.37	22.89	55.7	55.3	-	82.6	12.7	355 000	17.0
48 B - 1 M	3.00	76.2	45.72	48.26	29.24	70.5	65.3	-	98.5	20.6	560 000	26.0
56 B - 1 M	3.50	88.9	53.34	53.98	34.32	81.3	80.3	-	114.0	27.9	850 000	37.0
64 B - 1 M	4.00	101.6	60.96	63.50	39.40	92.0	93.3	-	130.0	36.2	1 120 000	50.0
72 B - 1 M	4.50	114.3	68.58	72.39	44.50	103.0	105.3	-	147.0	46.2	1 400 000	65.0

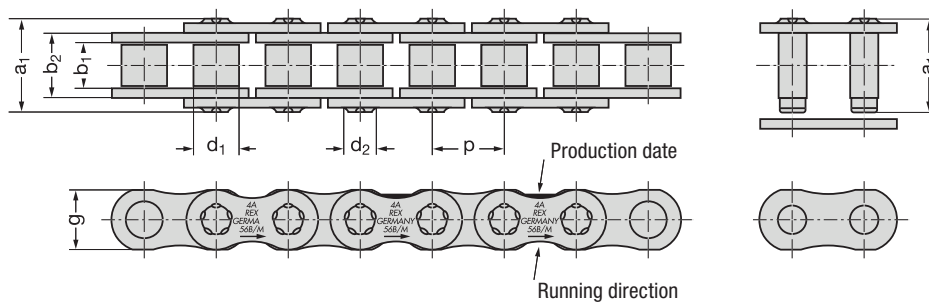

## Marine diesel version

High Performance from Rexnord.

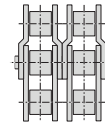

## Duplex roller chains



### Excellent Corrosion Protection

- 8 - 10 times better than the best competitors
- More than 100 % better in the buckling test
- Highly versatile, also suitable for aggressive environments



### Improved Wear Resistance

- 8 - 12 % improvement in comparison to predecessor
- Great protection through RexPro lubrication
- Long working life
- High operating reliability



### High Fatigue Resistance

- Ball-drifted plate holes
- Shot-peened chain links, seam-free rollers
- High pre-loading



### Eco friendly

- Through RexPro lubrication
- No heavy metals; Teflon- and silicone-free
- Environmental management system conforms to DIN EN ISO 14001



Rexnord meets the requirements of Machine Directive 2006/42/EC

## Duplex roller chains, ISO 606 / DIN 8187 (Marine-Diesel)

Chain No.	Pitch		Width between inner plates	Roller diameter	Pin diameter	Width over inner link	Plate depth	Transverse pitch	Pin length	Bearing area	Required minimum breaking strength DIN / ISO	Weight
	p	p										
	Inch	mm	b <sub>1</sub> min mm	d <sub>1</sub> max mm	d <sub>2</sub> max mm	b <sub>2</sub> max mm	g mm	e mm	a <sub>1</sub> max mm	A cm <sup>2</sup>	F <sub>u</sub> N	q kg/m
40 B - 2 M	2.50	63.5	38.10	39.37	22.89	55.7	55.3	72.29	154.0	25.5	630 000	34.0
48 B - 2 M	3.00	76.2	45.72	48.26	29.24	70.5	65.3	91.21	190.0	41.2	1 000 000	53.0
56 B - 2 M	4.50	88.9	53.34	53.98	34.32	81.3	80.3	106.60	221.0	55.8	1 600 000	74.0
64 B - 2 M	4.00	101.6	60.96	63.50	39.40	92.0	93.3	119.89	250.0	72.5	2 000 000	98.0
72 B - 2 M	4.50	114.3	68.58	72.39	44.50	103.0	105.3	136.27	283.0	92.4	2 500 000	128.0

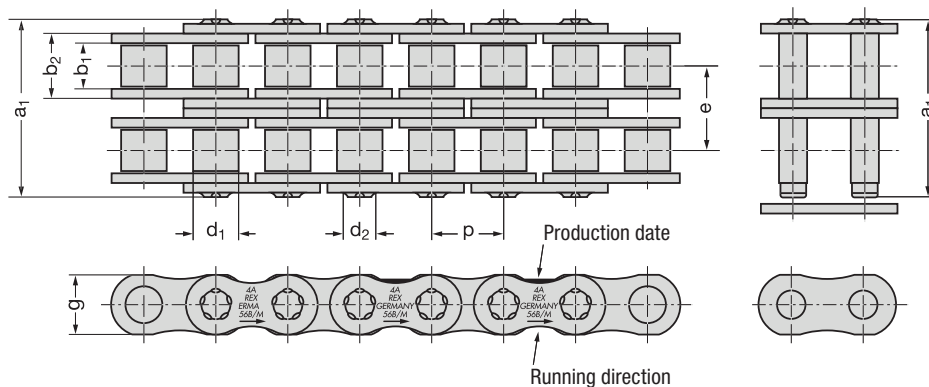

## Connecting dimensions for roller chains, European and American types

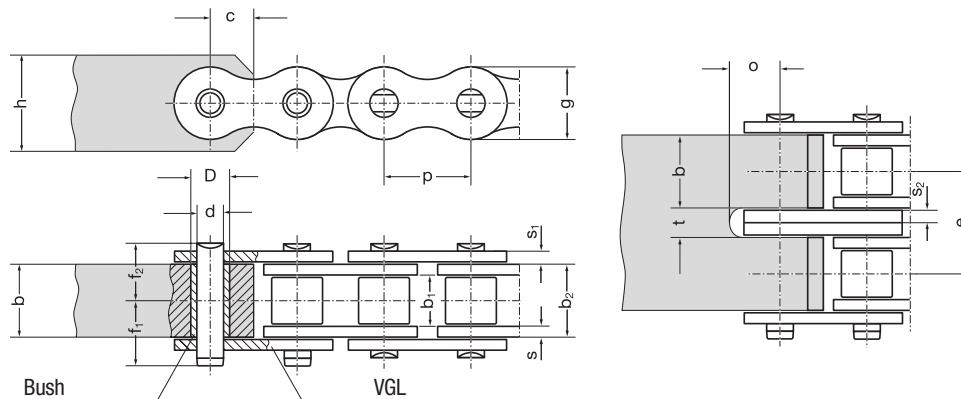

- Required material hardness of fixing elements: at least 490 N/mm<sup>2</sup>
- To increase wear resistance, fit a bush (surface hardness rating approx. 60 HRC) to the connecting element, if joint mobility is required at the connection point.
- Hardened bushes are not required in case of static loading
- Please order bushes using the corresponding bush part no.
- The bush bore diameters d<sup>C10</sup> result from press-fitting in bore diameter D<sup>S7</sup>
- If no bushes are fitted, the bore d<sup>C10</sup> is inserted directly into the connection element

### Connecting dimensions for roller chains, European type, ISO 606 / DIN 8187

Chain No.	Pitch		Width between inner plates		Width over inner link		Plate thickness						Bore Ø						Bush part no.
	p		b <sub>1</sub> min	b <sub>2</sub> max	s	s <sub>1</sub>	s <sub>2</sub>	g	e	f <sub>1</sub>	f <sub>2</sub>	h	b max	c	d <sup>C10</sup>	D <sup>S7</sup>	t	o	
	inch	mm	mm	mm	mm	mm	mm	mm	mm	mm	mm	mm	mm	mm	mm	mm	mm	mm	
08 B	0.50	12.70	7.75	11.30	1.70	1.70	1.25	11.60	13.92	10.30	8.40	11	11.20	6.0	4.45	6.27	2.7	7.5	001544
10 B	0.625	15.875	9.65	13.28	1.70	1.50	1.50	14.60	16.59	11.30	9.40	13	13.20	7.5	5.08	7.00	3.2	8.0	001543
12 B	0.75	19.05	11.68	15.62	1.80	1.80	1.80	15.90	19.46	13.20	11.10	16	15.60	10.0	5.72	8.40	3.8	9.5	001542
16 B	1.00	25.40	17.02	25.40	3.75	3.05	3.05	20.50	31.88	21.60	17.70	20	25.40	14.0	8.28	11.70	6.4	13.0	001541
20 B	1.25	31.75	19.56	29.00	4.50	4.50	3.50	25.70	36.45	24.10	20.20	26	29.00	16.5	10.19	14.00	7.4	16.5	001449
24 B	1.50	38.10	25.40	37.90	5.80	5.00	5.00	33.00	48.36	31.60	26.90	33	37.90	19.5	14.63	18.99	10.6	20.0	001540
28 B	1.75	44.45	30.99	46.50	6.50	5.50	6.00	37.00	59.56	36.60	31.60	36	46.50	23.0	15.90	21.64	12.6	24.0	001539
32 B	2.00	50.80	30.99	45.50	6.30	6.30	6.30	41.20	58.55	38.40	32.50	42	45.50	27.0	17.81	23.12	13.2	27.0	001538
40 B	2.50	63.50	38.10	55.70	8.50	8.00	8.00	51.50	72.29	47.50	39.40	52	55.70	35.0	22.89	29.18	16.6	35.0	017776
48 B	3.00	76.20	45.72	70.50	12.00	10.00	10.00	63.50	91.21	56.00	49.20	64	70.50	40.0	29.24	37.90	20.6	40.0	001535
56 B	3.50	88.90	53.34	81.30	13.60	12.00	12.00	77.00	106.60	64.80	57.80	77	81.30	45.0	34.32	43.50	25.0	51.0	001536

### Connecting dimensions for roller chains, American type, ISO 606 / DIN 8188

Chain No.	Pitch		Width between inner plates		Width over inner link		Plate thickness						Bore Ø						Bush part no.
	p		b <sub>1</sub> min	b <sub>2</sub> max	s	s <sub>1</sub>	g	e	f <sub>1</sub>	f <sub>2</sub>	h	b max	c	d <sup>C10</sup>	D <sup>S7</sup>	t	o		
	inch	mm	mm	mm	mm	mm	mm	mm	mm	mm	mm	mm	mm	mm	mm	mm	mm		
40	0.50	12.70	7.85	11.15	1.50	1.50	1.50	11.60	14.38	11.2	8.1	11	11.10	6.0	3.96	5.98	3.2	7.0	001544
50	0.625	15.875	9.40	13.80	2.00	2.00	2.00	14.60	18.11	12.0	10.2	13	13.80	7.7	5.08	7.65	4.2	9.0	001543
50	0.75	19.05	12.57	17.70	2.40	2.40	2.40	17.60	22.78	14.4	12.8	16	17.60	9.0	5.94	9.00	5.0	10.0	001542
80	1.00	25.40	18.75	22.50	3.05	3.05	3.05	23.50	29.29	20.4	16.5	22	22.30	12.0	7.92	11.67	6.8	14.0	001541
100	1.25	31.75	18.98	27.40	4.00	4.00	4.00	28.70	35.76	23.7	19.7	26	27.40	15.5	9.53	13.82	8.4	17.5	001449
120	1.50	38.10	25.22	35.30	4.70	4.70	4.70	34.40	45.44	30.0	24.9	30	35.20	18.5	11.10	16.13	9.8	20.0	001540
140	1.75	44.45	25.22	37.00	5.50	5.50	5.50	40.80	48.87	31.6	26.7	36	37.00	21.5	12.70	18.29	11.6	23.5	001539
160	2.00	50.80	31.55	45.00	6.30	6.30	6.30	47.80	58.55	36.4	31.8	42	44.70	24.0	14.27	20.70	13.2	27.5	001538
180	2.25	57.15	35.72	50.50	7.00	7.00	7.00	54.00	65.35	41.4	35.7	47	50.60	27.0	17.46	25.35	14.6	32.0	017776
200	2.50	63.50	37.85	54.70	8.00	8.00	8.00	60.00	71.55	45.0	39.0	52	54.60	30.0	19.84	28.38	16.6	34.5	001535
240	3.00	76.20	47.35	67.50	9.50	9.50	9.50	70.00	87.33	55.5	47.4	62	67.50	37.0	23.80	34.28	19.6	41.0	001536

MODULE\_04/GB/2014/02 // No liability accepted for misprints or errors!



## Overview Rexnord roller chains

### Roller Chains

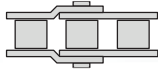

**REXNORD**  
**RexPro**  
RexPro lubrication  
improved wear resistance  
high fatigue resistance

- Outstanding protection against corrosion and wear
- Unique protection against chain joint stiffness
- Extremely eco-friendly

**REXNORD**  
**RexAthletic**  
good loading capacity  
extended lubrication intervals

- Durable and low-maintenance
- Longer servicing intervals
- High loading capacity

**REXNORD**  
**RexCarbon**  
no lubrication  
low noise

- Maintenance-free
- Low noise
- Eco-friendly

**REXNORD**  
**RexPlus**  
excellent corrosion resistance  
high reliability

- Excellent resistance to rust and acids
- Highly reliable
- Fulfills hygiene requirements
- NSF H1 certification

**REXNORD**  
**RexPlusCarbon**  
no lubrication  
excellent corrosion resistance

- Combination of RexPlus and RexCarbon
- Excellent resistance to rust and acids
- Maintenance-free
- NSF H1 certification

**REXNORD**  
**RexHiPro**  
good corrosion resistance  
excellent loading capacity

- Outstanding corrosion resistance
- Long service life
- High loading capacity

**Link-Belt**  
a brand of  
**REXNORD**

- The optimum choice for light and medium duty
- Good cost-benefit ratio
- High availability

**REXNORD**  
**RexProX**  
RexPro lubrication  
improved wear resistance  
high fatigue resistance

- Extremely high loading capacity
- Long service life
- Outstanding protection against corrosion and wear

### Leaf Chains

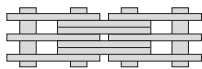

**REXNORD**  
**RexPro**  
RexPro lubrication  
improved wear resistance  
high fatigue resistance

- Outstanding protection against corrosion and wear
- Unique protection against chain joint stiffness
- Extremely eco-friendly

**REXNORD**  
**RexHiPro**  
good corrosion resistance  
excellent loading capacity

- Outstanding corrosion resistance
- Long service life
- High loading capacity

**REXNORD**  
**RexAthletic**  
good loading capacity  
extended lubrication intervals

- Durable and low-maintenance
- Longer servicing intervals
- High loading capacity

**REXDL**  
a brand of  
**REXNORD**

- The optimum choice for light and medium duty
- Good cost-benefit ratio
- Good availability